



Technical Bulb Guide

Innovation on the Move



More than just a bulb in a box

Innovation, OE quality and award winning products

Specialist bulbs

Quality Assured

24V bulbs

Largest range of bulbs
Innovators in Performance Halogens

LED Bulbs

HID Bulbs

Marketing Support
UK Technical Support and Customer Services

Merchandising and Planogramming

Industry-leading Cataloguing
Ranging

Up-to-date application guide

Staff training

Next day delivery
Award winning products





Welcome to Ring

Ring is a leading European supplier to the automotive aftermarket, providing exceptional quality bulbs, tyre care products, battery care products, dash cameras, garage and workshop equipment and vehicle conversion components. Ring has over 45 years' experience in the automotive sector, pushing the boundaries in automotive lighting, auto electrics and professional equipment.

Quality and service are at the centre of everything Ring does. We work with businesses to help them reach their goals, and ensure that our products perform exceptionally for the motorists, technicians, fleet managers and professionals using them on a daily basis. Our success has been shown in the 200+ product awards we've won throughout Europe, for products including our high performance halogen bulbs, tyre care, professional battery analysis tools and inspection lighting.

Headquartered in Leeds, UK, we are ideally placed to help meet the needs of our customers. Ring's specialist team of over 165 people across Europe, ensures we are at the forefront of product development, quality assurance and customer support services. From our purpose-built 6000m² distribution facility, Ring fulfils 64,000 orders to over 60 countries annually. UK customers benefit from a next day delivery service and with 6500 pallet locations in the warehouse holding 6000 different product lines, Ring is proud of its 97% availability rate, meaning customers get the products they need in a timescale that works for their business.

www.ringautomotive.com



Vehicle Lighting

12V Passenger Vehicles

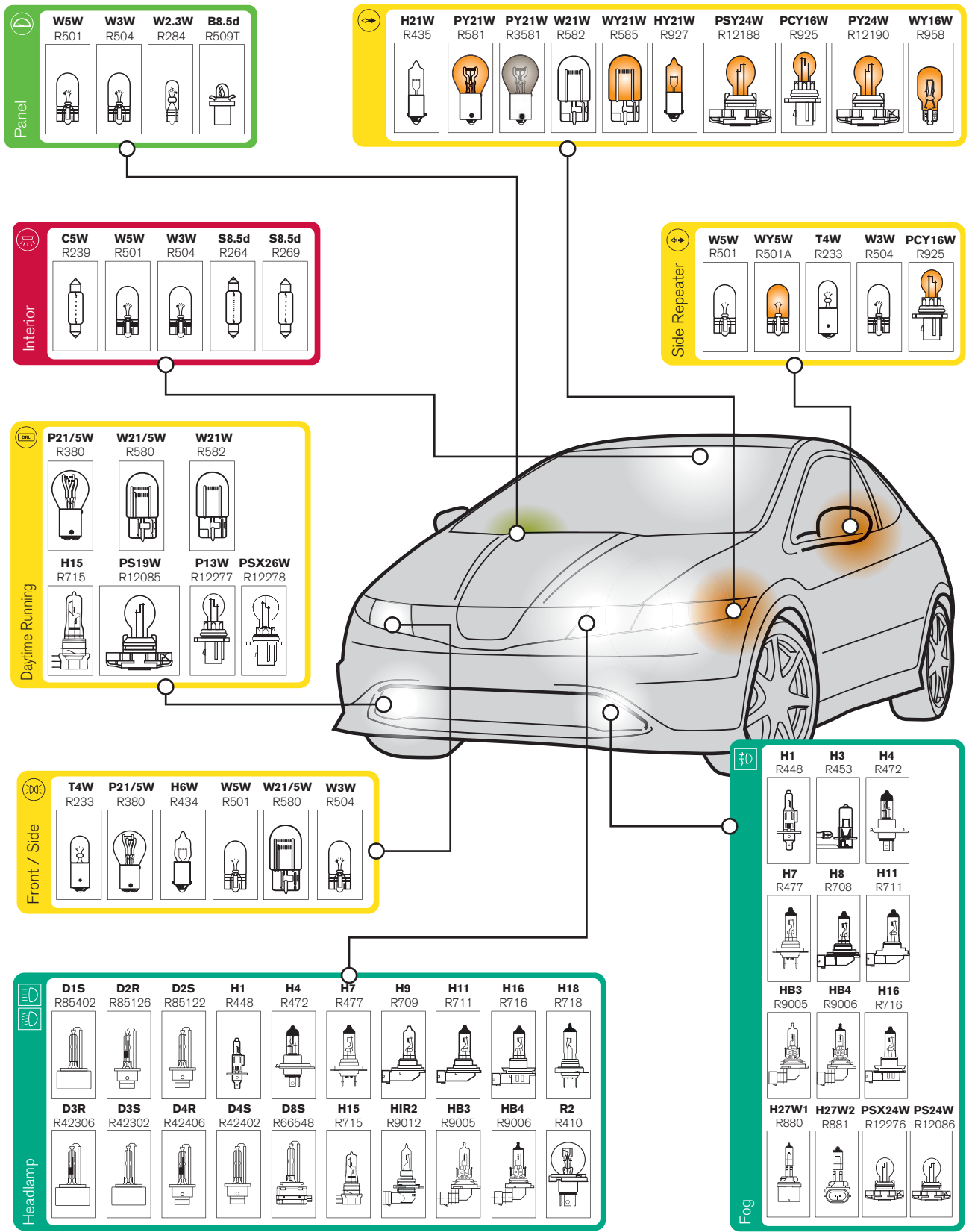

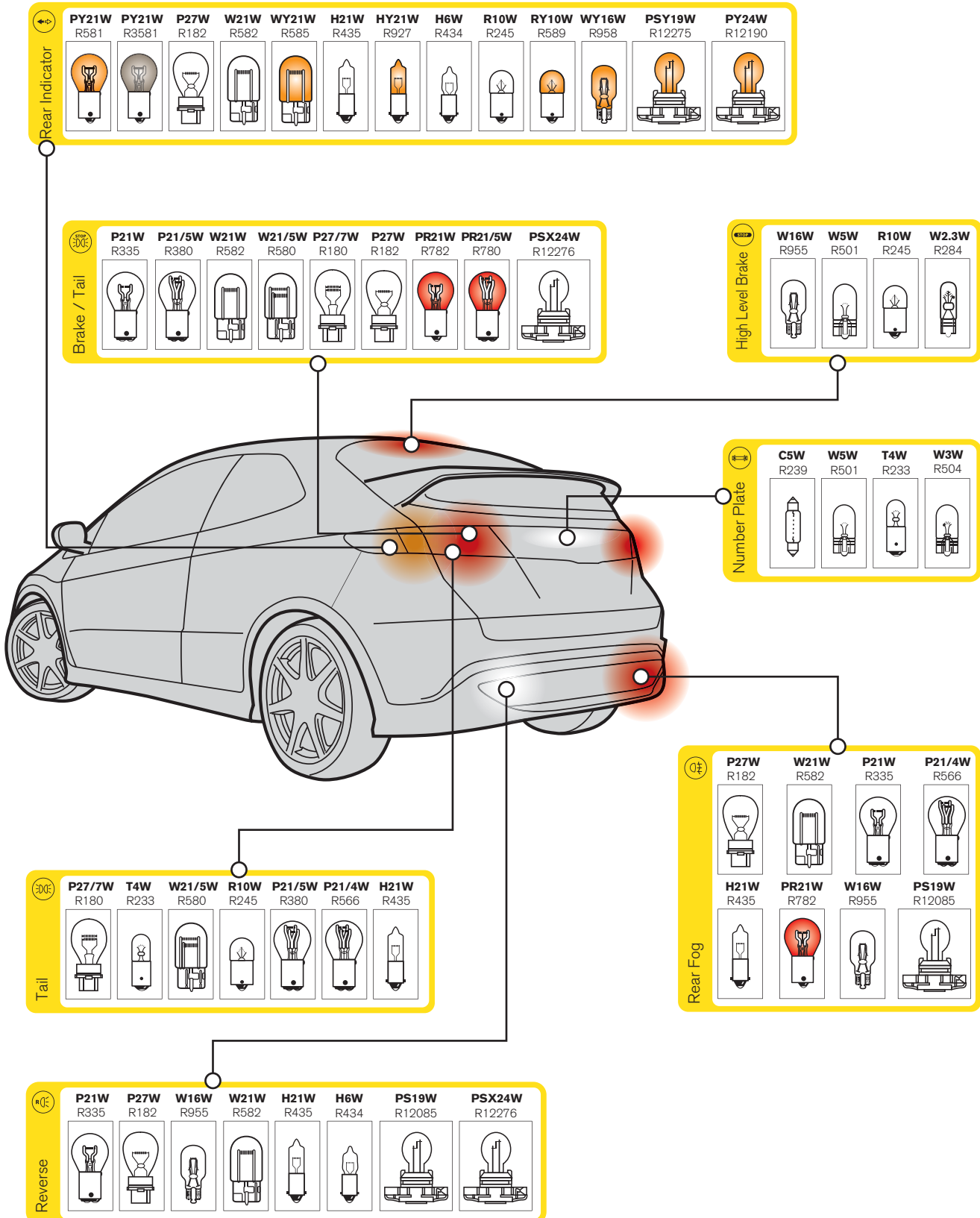

Vehicle Lighting

24V Commercial Vehicles

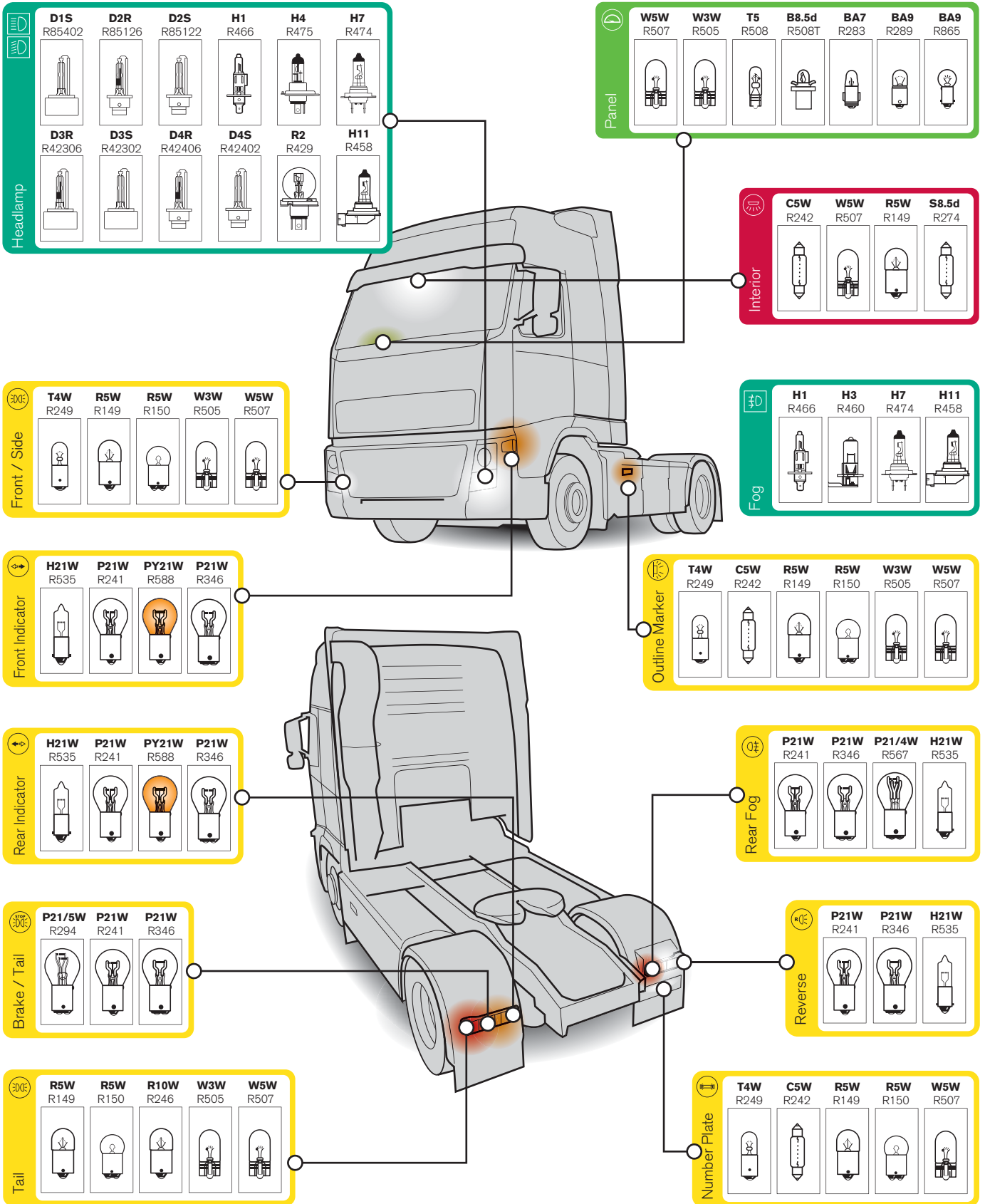

6V & 12V Motorcycles

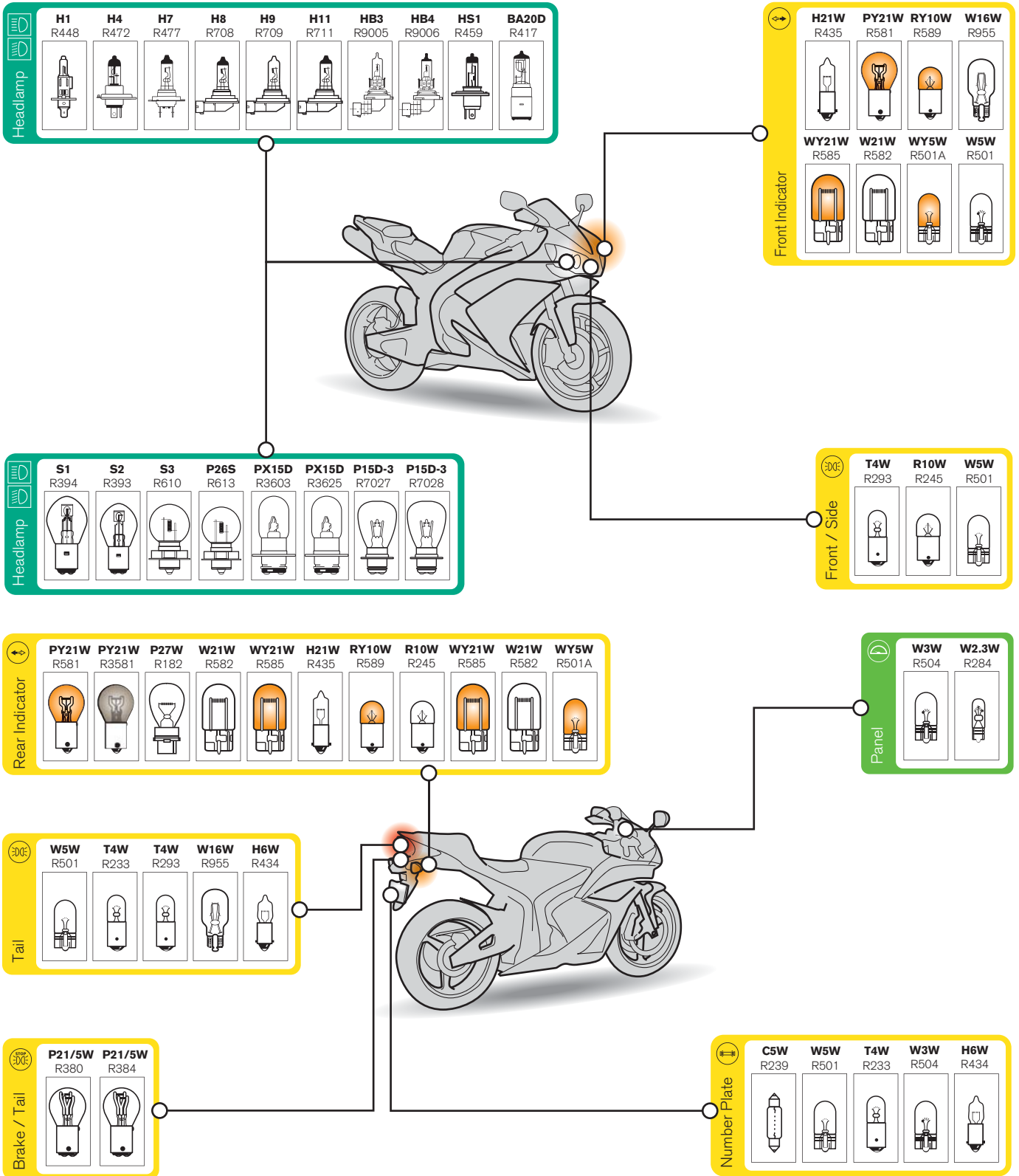

Vehicle Lighting

Which upgrade bulb should I choose?

BRIGHTER

I want more light on the road ahead

Xenon200 Brighter headlight bulbs

+200%
more light



Up to 200% more light on the road ahead. Our brightest performance headlamp bulb.



WHITER

I want a whiter looking headlamp

Xenon5000 Whiter Headlamp Bulbs

+50%
more light



Up to 5000K Xenon cool white light.



LONGER LIFE

I want a longer lasting headlamp



Long Life Headlamp

Lasts up to 3x longer than a standard equivalent bulb. Ideal for high mileage drivers.

Xenon150 Brighter Headlamp Bulbs

+150%
more light



Up to 150% more light on the road ahead allows the driver to see more.



Xenon4000 Whiter Headlamp Bulbs

+30%
more light



Up to 4000K Xenon cool white light.



OFF ROAD ONLY

I want a high power beam for off road driving

Xenon100 Brighter Headlamp Bulbs

+100%
more light



Up to 100%* more light on the road. Enhanced performance for greater light output.



RallySport Off-Road Headlamp Bulbs

OFF ROAD



Intense white light and high power beam (80 – 100W).



SportzBlue Off-Road Headlamp Bulbs

OFF ROAD



Intense blue-white light and high power beam (80 – 100W).



*compared to standard halogen bulb



**NOW IN 100%
RECYCLABLE PACKAGING
AND 100% PLASTIC FREE**



Performance Halogens 9

Xenon200

Brighter headlight bulbs

Ring's brightest performance headlamp bulb

- Up to 200% more light on the road ahead allowing drivers to see more
- See and be seen with a longer beam pattern
- Better visibility of road markings and signs
- Up to 3700K colour temperature meaning a whiter look in the headlamp compared to a standard bulb
- No changes to vehicle wiring required

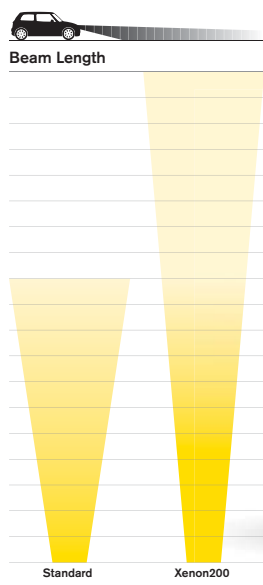

+200%

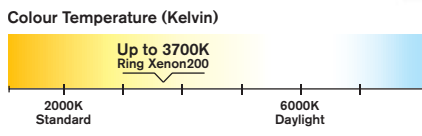

Twin Pack

Ref	Voltage	Wattage	ECE	Cap	Upgrades	Barcode
RX2072	12V	60/55W	H4	P43t	R472	5055175250076
RX2077	12V	55W	H7	PX26d	R477	5055175250083
RX2011	12V	55W	H11	PGJ19-2	R711	5055175251295

Retail Solution

Part No	Description	Barcode
BU0200	Ring Xenon200 counter top display unit c/w 5 x H7, 3 x H4	5055175251028



BU0200

*Compared to standard halogen bulb. Images shown for illustration purposes only and may differ to actual product.

Vehicle Lighting

Performance Halogens 10

 NOW IN 100% RECYCLABLE PACKAGING AND 100% PLASTIC FREE

Standard Beam

Xenon150 Beam

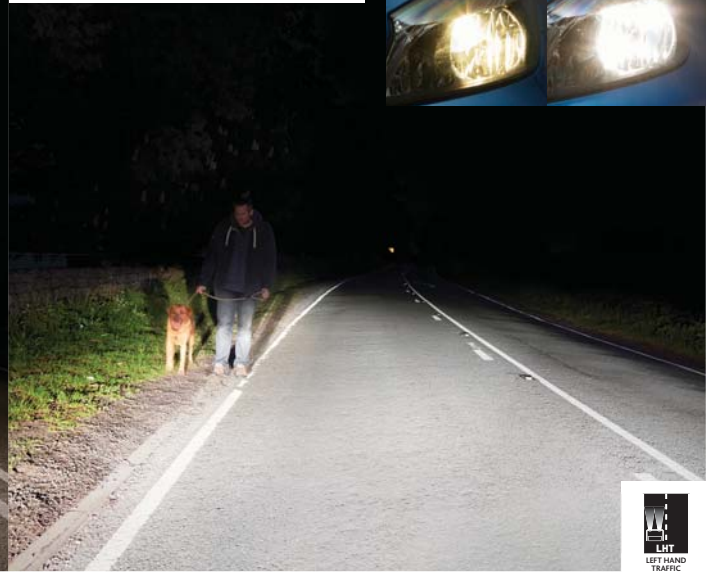

Xenon150 Brighter Headlamp Bulbs

Puts up to 150%* more light on the road

- Up to 150% more light on the road ahead allows the driver to see more
- Better visibility of road markings and signs
- A whiter look in the headlamp compared to a standard bulb
- No changes to vehicle wiring required



+150%

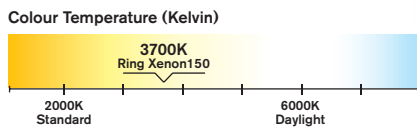

Twin

Part No	Voltage	Wattage	ECE	Cap	Upgrades	Barcode
RX1548	12V	55W	H1	P14.5s	R448	5055175250182
RX1572	12V	60/55W	H4	P43t	R472	5055175250199
RX1577	12V	55W	H7	PX26d	R477	5055175250205
RX1511	12V	55W	H11	PGJ19-2	R711	5055175250212
RX1512	12V	55W	HIR2	PX22D	R9012	5055175251011

*Compared to standard halogen bulb.

**NOW IN 100%
RECYCLABLE PACKAGING
AND 100% PLASTIC FREE**

Standard Beam

Xenon100 Beam



Xenon100

Brighter Headlamp Bulbs

Puts up to 100%* more light on the road

- Xenon gas technology and precise filament for improved performance
- Increased light output allows other road users to be seen more clearly at a distance of 40m on dipped beam
- Provides better reflections from road markings and signs
- No changes to wiring required

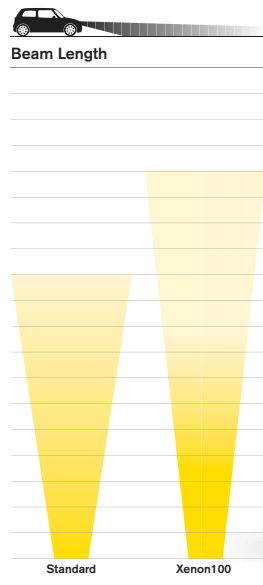

+100%

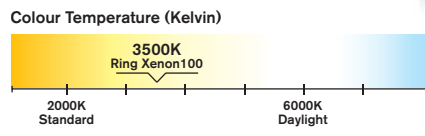

Twin

Part No	Voltage	Wattage	ECE	Cap	Upgrades	Barcode
RX1048	12V	55W	H1	P14.5s	R448	5055175250229
RX1072	12V	60/55W	H4	P43t	R472	5055175250236
RX1077	12V	55W	H7	PX26d	R477	5055175250243
RX1005	12V	60W	HB3	P20d	R9005	5055175250267
RX1006	12V	51W	HB4	P22d	R9006	5055175250274
RX1011	12V	55W	H11	PGJ19-2	R711	5055175250250

*Compared to standard halogen bulb.

Vehicle Lighting

Performance Halogens 12

 NOW IN 100% RECYCLABLE PACKAGING AND 100% PLASTIC FREE

Standard Beam

Xenon5000 Beam



Xenon5000 Whiter Headlamp Bulbs

5000K

+50%

The whitest road legal bulb

- Enhance the look of your vehicle
- Creates an LED headlamp look
- White light blends with LED DRL lamps
- Closer to daylight for a more comfortable night time drive
- See road signs and markings earlier with reflective white light
- Crisp white light and high power beam
- Puts up to 50%* more light on the road for safer and more comfortable night driving



Colour Temperature (Kelvin)

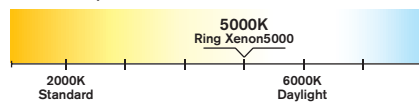

Twin

Part No	Voltage	Wattage	ECE	Cap	Upgrades	Barcode
RX5048	12V	55W	H1	P14.5s	R448	5055175250540
RX5072	12V	60/55W	H4	P43t	R472	5055175250557
RX5077	12V	55W	H7	PX26d	R477	5055175250564
RX5011	12V	55W	H11	PGJ19-2	R711	5055175250571

*Compared to standard halogen bulb.



Xenon4000

Whiter Headlamp Bulbs

4000K +30%

Enhance the look of your vehicle

- Crisp white light
- H4 and H7 references have stylish silver tip to blend into headlamp when unlit
- Puts up to +30% more light on the road
- Whiter light gives better reflections from signs and road markings
- Ideal to colour match to LED daytime running lamps
- No changes to vehicle wiring required

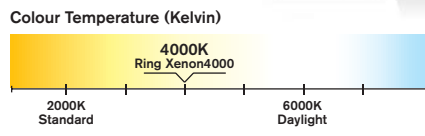

Twin

Part No	Voltage	Wattage	ECE	Cap	Upgrades	Barcode
RX4048	12V	55W	H1	P14.5S	R448	5055175250328
RX4072	12V	60/55W	H4	P43t	R472	5055175250335
RX4077	12V	55W	H7	PX26d	R477	5055175250342

Vehicle Lighting

Performance Halogens 14

 NOW IN 100% RECYCLABLE PACKAGING AND 100% PLASTIC FREE

Standard Beam



SportzBlue Beam



SportzBlue

Off-Road Headlamp Bulbs

Off-road* intense white light with blue reflector hue

- Up to 3900K white light with a darker blue hint
- 80-100W produces a high power beam pattern
- Ideal for off-roaders, sports and rally drivers
- Changes to wiring or fuses may be required
- Off road use only

3900K



Colour Temperature (Kelvin)

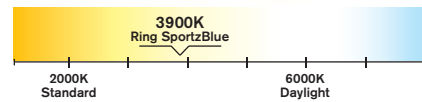

Twin

Part No	Voltage	Wattage	ECE	Cap	Upgrades	Barcode
RX668	12V	80W	H1	P14.5s	R448	5055172250618
RX684	12V	100/80W	H4	P43t	R472	5055175250625
RX664	12V	80W	H7	PX26d	R477	5055175250632

*Products are not ECE approved and are for off-road use only.

NOW IN 100%

 RECYCLABLE PACKAGING

 AND 100% PLASTIC FREE

Standard Beam



RallySport Beam

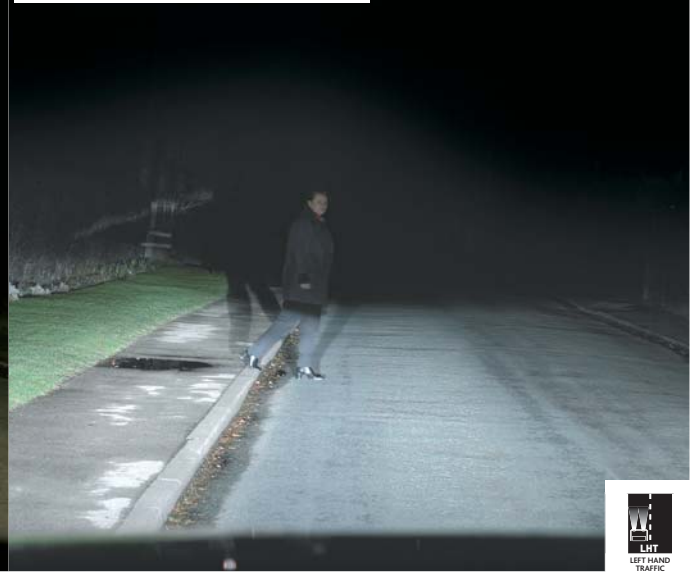

Performance Halogens 15

RallySport

Off-Road Headlamp Bulbs

Off-road* intense white light and high power beam

- 80-160W produces a high power beam pattern
- Off road use only
- Ideal for sport or rally drivers
- Changes to wiring or fuses may be required

3500K



Colour Temperature (Kelvin)

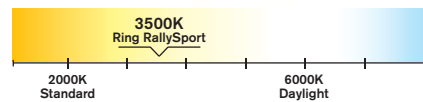

Twin

Part No	Voltage	Wattage	ECE	Cap	Upgrades	Barcode
RX481	12V	100W	H1	P14.5s	R448	5055175250588
RX484	12V	100/80W	H4	P43t	R472	5055175250595
RX464	12V	100W	H7	PX26d	R477	5055175250601

Single

Part No	Voltage	Wattage	ECE	Cap	Upgrades	Barcode
R481	12V	100W	H1	P14.5s	R448	5011274048105
R484	12V	100/80W	H4	P43t	R472	5011274048402
R464	12V	100W	H7	PX26d	R477	5011274046408

*Products are not ECE approved and are for off-road use only.

Vehicle Lighting

LED Bulbs 16



Whiter Sidelights

- Designed to 'colour match' headlamp upgrade bulbs
- Create a whiter look by upgrading your sidelight bulbs to match the latest performance halogen upgrade bulbs
- Whiter bulbs will enhance the look of your vehicle particularly those with Daytime Running Lights

Upgrade to a stylish look

- Direct replacement for existing bulbs
- Optional plug and play resistor kit for vehicles with bulb failure warning system (LED501RES / LED382RES)
- Off road or internal use only

Colour Temperature (Kelvin)

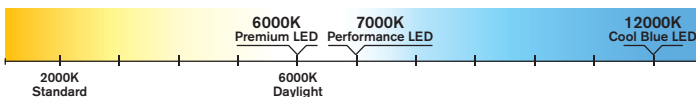

12V Bulbs - Boxed

Part Number	Bulb Ref	Bulb Type	Application	Colour Temp	Lumens	More Info	Barcode
R801	501	W5W	Sidelight & Interior	3400K			5011274080105
R833	233	T4W	Sidelight	3400K			5011274083304
R1401	501	W5W	Sidelight & Interior	3500K			5055175244945

12V Bulbs - Blister packed

Part Number	Bulb Ref	Bulb Type	Application	Colour Temp	Lumens	More Info	Barcode
RW801	501	W5W	Sidelight & Interior	3400K			5011274180126
RW833	233	T4W	Sidelight	3400K			5011274183325
RW1401	501	W5W	Sidelight & Interior	3500K			5055175231952
RW882	582	W21W	Sidelight	4000K			5055175244952
RW888	580	W21/5W	Sidelight	4000K			5055175244976

12V LEDs - Blister packed

Part Number	Bulb Ref	Bulb Type	Application	Colour Temp	Lumens	More Info	Barcode
RW2396LED	239	C5W	Number Plate & Interior	6000K	35	39mm White	5055175229553
RW23912LED	239	C5W	Number Plate & Interior	12000K	35	39mm Blue	5055175232492
RW5016LED	501	W5W	Sidelight & Interior	6000K	40	White	5055175229546
RW50112LED	501	W5W	Sidelight & Interior	12000K	35	Blue	5055175232485
LED501RES		W5W/W3W				LED Resistor kit for W5W	5055175227627



LED bulbs for a whiter look

- Latest CANbus technology
- Up to 6000K bulbs
- Longer life
- Vibration resistant
- Extra bright
- Off road or internal use only



Colour Temperature (Kelvin)

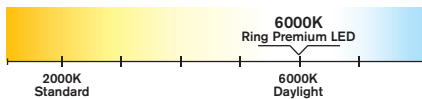

12V Premium LEDs - Display Box

Part Number	Bulb Ref	Bulb Type	Application	Colour Temp	Lumens	More Info	Barcode
RW207LED	207/245	R5W/R10W	Signalling	6000K	400		5055175237091
RW239CBLED	239	C5W	Number Plate & Interior	6000K	200	CANbus Technology	5055175237060
RW380LED	380	P21/5W	Signalling	6000K	510/150		5055175237039
RW382LED	382	P21W	Signalling	6000K	530		5055175237046
RW477FLED	477	H7	Fog Lamp only	6000K	600		5055175237022
RW501CBLED	501	W5W	Sidelight & Interior	6000K	220	CANbus Technology	5055175237053
RW711FLED	711	H11	Fog Lamp only	6000K	600		5055175237015

24V Premium LEDs - Display Box

Part Number	Bulb Ref	Bulb Type	Application	Colour Temp	Lumens	More Info	Barcode
RB1496LED	149	R5W	Signalling	6000K	400		5055175237268
RB1506LED	150	R5W	Signalling	6000K	400		5055175237275
RB2416LED	241	P21W	Signalling	6000K	530		5055175237282
RB2426LED	242	C5W	Number Plate & Interior	6000K	200	CANbus Technology	5055175237244
RB2496LED	249	T4W	Signalling	6000K	200		5055175237299
RB5076LED	507	W5W	Sidelight & Interior	6000K	220	CANbus Technology	5055175237251

Vehicle Lighting

Performance LED Bulbs 18



LED bulbs for a whiter look

- 3D technology
- Up to 7000K bulbs
- Longer life
- Vibration resistant
- Extra bright
- Off road or internal use only

Colour Temperature (Kelvin)

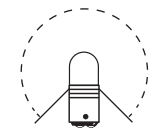
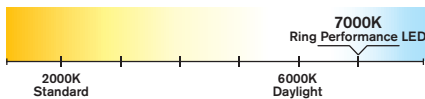

270° Light distribution

3D Technology

Many LED designs are '2D': 2D LEDs have a flat surface forcing the light to be emitted in one direction only. This can be a problem with LEDs, as no matter how many other LEDs are added to the lamp in any position, the light distribution may be uneven. Our 3D LEDs are made with a flexible LED beading which can be used to simulate the shape of a standard bulb thus giving an even light distribution.

12V Performance LEDs - Display Box

Part Number	Bulb Ref	Bulb Type	Application	Colour Temp	Lumens	More Info	Barcode
RW380DLED	380	P21/5W	Signalling	7000K	300/100	3D Technology	5055175237077
RW382DLED	382	P21W	Signalling	7000K	560	3D Technology	5055175237084
RW501DLED	501	W5W	Side & Interior	7000K	200	3D Technology	5055175237107

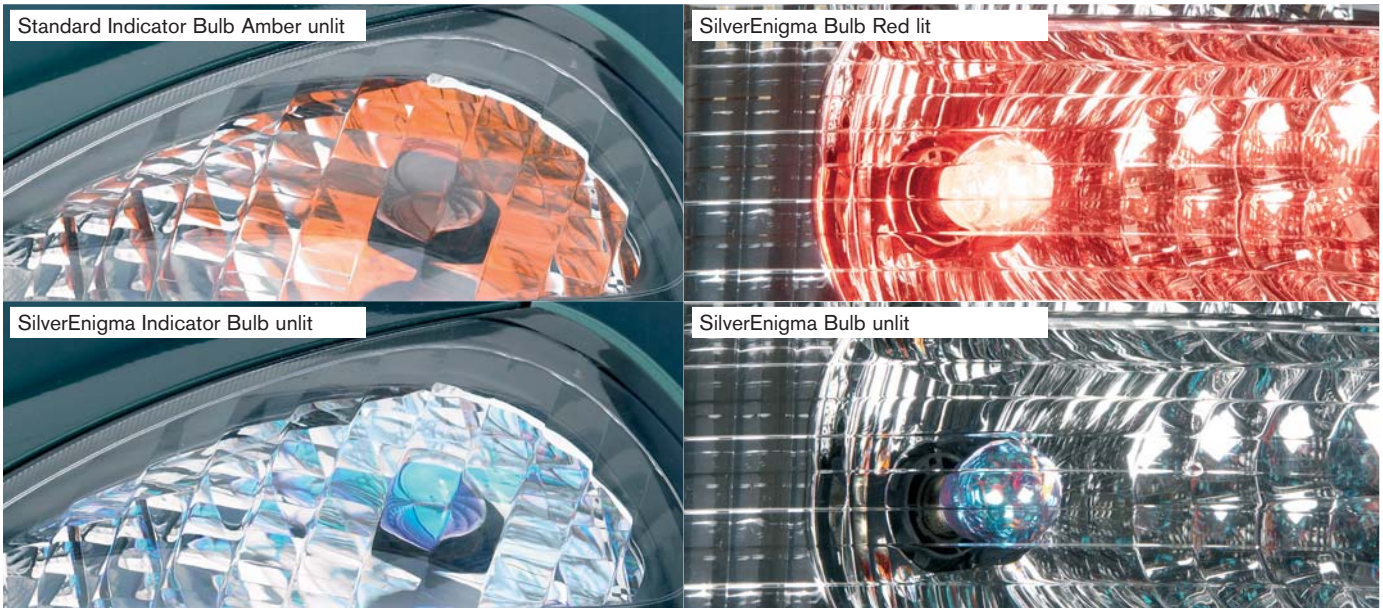

SilverEnigma Styling Bulb

Flashes amber, looks clear when unlit

- Flashes amber and provides a clear integrated look when unlit
- Ring SilverEnigma is interchangeable with conventional bulbs
- Upgrades R581 amber indicator bulb



Illuminates red, looks clear when unlit

- Illuminates red and provides a clear integrated look when unlit
- Vehicle Specific OE replacement bulb
- Upgrades R782 stop light bulb
- Upgrades R780 stop and tail bulb

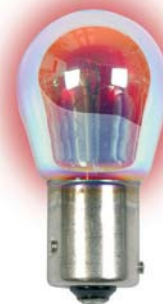

Boxed

Part No	Voltage	Wattage	ECE	Cap	Upgrades	Barcode
R3782	12V	21W	PR21W	BAW15s	R782	5055175215013
R3780	12V	21/5W	PR21/5W	BAW15d	R780	5055175215020

Blister packed

Part No	Voltage	Wattage	ECE	Cap	Upgrades	Barcode
RW3581	12V	21W	PY21W	BAU15s	R581	5011274168414

Vehicle Lighting



Designed for today's modern headlamp units

- Optimise the efficiency of lighting equipment with Ring Premium headlamp bulbs
- The output and efficiency of vehicle headlamps is not only determined by the shape, size and manufacturing quality of the reflector but also the quality of the bulb
- Smaller headlamp designs require a bulb with a more precise filament position



Ring Premium Headlamp Bulb Range – Single Blister

Part Number	Voltage	Wattage	ECE	Cap	Barcode
RU448EQ	12V	55W	H1	P14.5s	5011274184414
RU472EQ	12V	60/55	H4	P43t	5055175201016
RU477EQ	12V	55	H7	PX26d	5055175201030

Ring Premium Headlamp Bulb Range – Twin Blister

Part Number	Voltage	Wattage	ECE	Cap	Barcode
RW448EQ	12V	55W	H1	P14.5s	5011274144845
RW472EQ	12V	60/55W	H4	P43t	5055175201030
RW477EQ	12V	55W	H7	PX26d	5055175201047



- Ring Xenon HID bulbs are OE manufactured
- Direct OE replacement for existing discharge bulb
- Long life – 3000 hours
- E Approved / Road legal

Ring Xenon HID - Boxed

Part Number	Voltage	Wattage	ECE	Cap	Barcode
R85402	85V	35W	D1S	PK32d-2	5055175215112
R85126	85V	35W	D2R	P32d-3	5055175211480
R85122	85V	35W	D2S	P32d-2	5055175211473
R42306	42V	35W	D3R	PK32d-6	5055175235882
R42302	42V	35W	D3S	PK32d-5	5055175230610
R42406	42V	35W	D4R	P32d-6	5055175235899
R42402	42V	35W	D4S	P32d-5	5055175230627

4100K
Standard colour temperature



Colour Temperature (Kelvin)

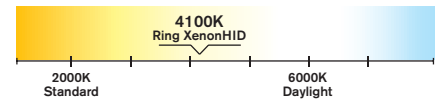

Ring Xenon HID - Blister Pack

Part Number	Voltage	Wattage	ECE	Cap	Barcode
RU85402	85V	35W	D1S	PK32d-2	5055175220222
RU85126	85V	35W	D2R	P32d-3	5055175220215
RU85122	85V	35W	D2S	P32d-2	5055175220208
RU42302	42V	35W	D3S	PK32d-5	5055175242903
RU42402	42V	35W	D4S	P32d-5	5055175242910

Fitting Video

Scan to watch the video



All Ring HID bulbs are Lead free.
All Ring D3 and D4 bulbs are Mercury free.

Vehicle Lighting



Lasts up to 3x longer than the standard equivalent bulb

- Ideal for day and night use and high mileage drivers
- Improved resistance to vehicle overvoltage
- Suitable for vehicles with optional 'lights on' function or daytime running systems

Coping with Overvoltage

On many of today's modern vehicles the measured voltage can be higher than 12V in order to cope with the additional electronic devices and electric motors.

Bulbs for cars are currently manufactured to operate at 12V and tested at 13.2V however, if the constant running voltage is higher than this it can result in a rapid decrease in the life expectancy of the bulb. Ring Automotive's Long Life bulbs provide a better resistance to vehicle overvoltage.



Blister Pack

Part Number	Voltage	Wattage	ECE	Cap	Barcode
RU477LL	12V	55W	H7	PX26d	5011274147747
RU472LL	12V	60/55W	H4	P43t	5011274147242
RU448LL	12V	55W	H1	P14.5s	5011274144852
RU453LL	12V	55W	H3	PK22s	5011274045333
RW380LL	12V	21/5W	P21/5W	BAY15d	5011274138042
RW382LL	12V	21W	P21W	BA15s	5011274138240
RW207LL	12V	5W	R5W	BA15s	5011274120740
RW245LL	12V	10W	R10W	BA15s	5011274124540
RW501LL	12V	5W	W5W	W2.1x9.5d	5011274250195
RW239LL	12V	5W	C5W	S8.5d 11x38mm	5011274123949
RW581LL	12V	21W	PY21W	BAU15s	5011274158149
RW233LL	12V	4W	T4W	BA9s	5011274123345

*Headlamps only



Gain time, gain distance, avoid rear end collisions

- Faster light-up* and greater light intensity provides earlier warning to following vehicles
- A shorter, more precise filament produces up to 20% more luminance than a standard bulb
- Up to 3 metres** extra stopping distance



Twin Blister Pack

Part No	Voltage	Wattage	ECE	Cap	Upgrades	Barcode
RW380RR	12V	21/5W	P21/5W	BAY15d	R380	5055175215303
RW382RR	12V	21W	P21W	BA15s	R382	5055175215310
RW207RR	12V	5W	R5W	BA15s	R207	5055175215327
RW245RR	12V	10W	R10W	BA15s	R245	5055175215334

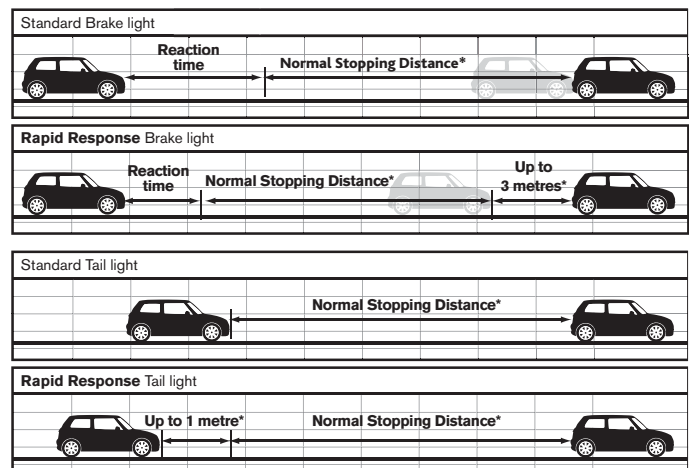

*Based on travelling speeds of 62mph

*Faster light applies to brake and tail, and brake, tail and indicator bulbs only.

**Up to 3 metres applies to brake and tail and brake bulbs only.

Vehicle Lighting



Retail Blister Packs - Profit makers

Twin packed blister bulbs offer a greater profit making opportunity than single blister, especially as a consumer is less likely to shop around when selecting a replacement bulb which is normally an emergency purchase.

In addition as the footprint of the card is the same it will yield more profit per linear foot than a single pack.

RW= 
Twin Blister Pack

RU= 
Single Blister Pack

Single Blister Pack

ECE Ref → **W21/5W**
Part Number → **RU580**
Bulb type → **brake & tail**
Voltage → 12v 21/5w W3x16q



Twin Blister Pack

P21W
RW335
brake/indicator
12v 21w BA15d



Hints and tips on changing the bulb

ECE Ref → **UPGRADE P21/5W**
Part Number → **RW380RR**
Bulb type → **brake & tail**
Voltage → 12v 21/5w BAY15d



Additional information to aid decision making

Colour coded to highlight range → Provides earlier warning to following vehicles



12V and 24V Bulbs

With a range of over 650 references, Ring offers a one stop shop for autobulbs, from the fastest selling retail headlamp bulbs to specialist bulbs for the Engineering specifier in the commercial vehicle and construction equipment markets

Designed and manufactured to OE standards and E approved, where required, to ECE regulation 37 or 99, every bulb in the range is quality assured through our Quality Assurance department. You can rest assured that all the bulbs have been developed, tested and approved by our engineers.

Innovation is key to our bulb range, developing the latest technology performance bulbs for our customers. Ring are at the forefront of developing OE bulbs and making them available to the aftermarket as soon as a new vehicle application enters the market, ensuring that our customers can offer the same bulbs as the vehicle manufacturers.

Available in boxed packs for trade or in blister packs for self selection retail sale.



12V Single Bulb Blister Pack Headlamps

12V Twin Blister Pack

Part No	Voltage	Wattage	ECE	Cap	Application	Colour	Pack Qty	Barcode	Ref	Pack Qty	Barcode
RU12	12V	60/55W	(H4)**	P45t			10 x 1	5011274101213			
RU410	12V	45/40W	R2 ASY	P45t			10 x 1	5011274141011			
RU448	12V	55W	H1	P14.5s			10 x 1	5011274144814			
RU453	12V	55W	H3	PK22s			10 x 1	5011274145316	RW453	10 x 1	5055175209739
RU472	12V	60/55W	H4	P43t			10 x 1	5011274147211	RW472	10 x 1	5011274147273
RU477	12V	55W	H7	PX26d			10 x 1	5011274147716	RW477	10 x 1	5011274147723
RU479	12V	55W	H2	X511			10 x 1	5011274147969			
RU480	12V	100W	(H2)**	X511			10 x 1	5011274148010			
RU491	12V	130W	(H2)**	X511			10 x 1	5011274149161			
RU708	12V	35W	H8	PGJ19-1			10 x 1	5011274170813			
RU709	12V	65W	H9	PGJ19-5			10 x 1	5011274057091			
RU711	12V	55W	H11	PGJ19-2			10 x 1	5011274057114			
RU715	12V	55/15W	H15	PGJ23t-1			10 x 1	5055175217536			
RU716	12V	19W	H16	PGJ19-3			10 x 1	5055175243740			
RU880	12V	27W	H27W/1	PG13			10 x 1	5011274188016			
RU881	12V	27W	H27W/2	PGJ13			10 x 1	5011274188115			
RU9005	12V	60W	HB3	P20d			10 x 1	5011274190538			
RU9006	12V	51W	HB4	P22d			10 x 1	5011274090067			
RU9012	12V	55W	HIR2	PX22d			10 x 1	5055175243627			

*Headlamps only **Off road use only

Vehicle Lighting

12V Single Bulb Blister Pack Exterior/Interior

12V Twin Blister Pack

Part No	Voltage	Wattage	ECE	Cap	Application	Colour	Pack Qty	Barcode	Ref	Pack Qty	Barcode
RU180	12V	27/7W	P27/7W	W2.5x16q			10 x 1	5011274118013			
RU182	12V	27W	P27W	W2.5x16d			10 x 1	5011274118211			
RU183	12V	27/7W	PY27/7W	WX2.5x16q			10 x 1	5011274018368			
RU207	12V	5W	R5W	BA15s			10 x 1	5011274120719	RW207	10 x 1	5011274120726
RU209	12V	5W	R5W	BA15d			10 x 1	5011274120917	RW209	10 x 1	5011274120924
RU233	12V	4W	T4W	BA9s			10 x 1	5011274123314	RW233	10 x 1	5011274123321
RU237	12V	7W		S8.5d 10x40mm		Frosted	10 x 1	5011274123710	RW237	10 x 1	5011274123727
RU239	12V	5W	C5W	S8.5d 11x38mm			10 x 1	5011274123918	RW239	10 x 1	5011274123925
RU245	12V	10W	R10W	BA15s			10 x 1	5011274124519	RW245	10 x 1	5011274124526
RU256	12V	3W		S7d 8x38mm			10 x 1	5011274125615	RW256	10 x 1	5011274125622
RU264	12V	10W		S8.5d 11x44mm			10 x 1	5011274126414	RW264	10 x 1	5055175202518
RU265	12V	10W		S8.5d 15x44mm			10 x 1	5011274126513			
RU269	12V	10W		S8.5d 11x30mm			10 x 1	5011274126919	RW269	10 x 1	5011274126933
RU958	12V	16W	WY16W	W2.1x9.5d		Amber	10 x 1	5055175243634			
RU270	12V	18W		S8.5d 15x44mm			10 x 1	5011274127015			
RU272	12V	10W		S8.5d 11x38mm			10 x 1	5011274127213	RW272	10 x 1	5011274127206
RU273	12V	21W		S8.5d 15x44mm			10 x 1	5011274127312	RW273	10 x 1	5011274127329
RU280	12V	1.5W		LES E5/8			10 x 1	5011274128012			
RU281	12V	2W		BA7s			10 x 1	5011274128111	RW281	10 x 1	5011274128128
RU284	12V	2.3W	W2.3W	W2x4.6d			10 x 1	5011274128425	RW284	10 x 1	5011274128432
RU286	12V	1.2W		W2x4.6d			10 x 1	5011274128616	RW286	10 x 1	5011274128623
RU286A	12V	1.2W		W2x4.6d		Amber	10 x 1	5011274128517			
RU286G	12V	1.2W		W2x4.6d		Green	10 x 1	5011274128654	RW286G	10 x 1	5055175203201
RU286R	12V	1.2W		W2x4.6d		Red	10 x 1	5011274128531			
RU297	12V	2.2W		W2.1x9.5d			10 x 1	5011274129712	RW297	10 x 1	5055175203188
RU32/3	12V	32/4W		BAY15d			10 x 1	5011274132316			
RU335	12V	21W	P21W	BA15d			10 x 1	5011274133511	RW335	10 x 1	5011274133528
RU343	12V	21W		BA15s		Amber	10 x 1	5011274134365			
RU380	12V	21/5W	P21/5W	BAY15d			10 x 1	5011274138011	RW380	10 x 1	5011274138028
RU382	12V	21W	P21W	BA15s			10 x 1	5011274138219	RW382	10 x 1	5011274138226
RU433	12V	20W		BA9s			10 x 1	5011274143312			
RU434	12V	6W	H6W	BAX9s			10 x 1	5011274143411	RW434	10 x 1	5055175202532
RU435	12V	21W	H21W	BAY9s			10 x 1	5011274143510			
RU501	12V	5W	W5W	W2.1x9.5d			10 x 1	5011274150112	RW501	10 x 1	5011274150129
RU501A	12V	5W	WY5W	W2.1x9.5d		Amber	10 x 1	5011274150181	RW501A	10 x 1	5011274151195
RU504	12V	3W	W3W	W2.1x9.5d			10 x 1	5011274150419	RW504	10 x 1	5011274150426
RU509T	12V	1.2W		B8.5D		Black base	10 x 1	5011274150914	RW509T	10 x 1	5055175202549
RU509TBBK	12V	1.2W		B8.3D		Black base	10 x 1	5011274150990			
RU509TGR	12V	2W		BX8.5D		Green base	10 x 1	5011274150945			
RU509TMBE	12V	1.5W		BX8.4D		Beige Base	10 x 1	5011274150938			
RU509TMBK	12V	1.2W		BX8.4D		Black base	10 x 1	5011274150921			
RU509TMBL	12V	1.2W		B8.4D		Blue Base	10 x 1	5011274290528			
RU509TMGR	12V	2W		BX8.4D		Green base	10 x 1	5011274290542			
RU509TMOR	12V	1.12W		BX8.4D		Orange base	10 x 1	5011274150983			
RU509TOR	12V	1W		BX8.5D		Orange base	10 x 1	5011274290535			
RU509TWGY	12V	1.2W		B8.7D		Grey base	10 x 1	5011274290559			

12V Single Bulb Blister Pack Exterior/Interior

12V Twin Blister Pack

Part No	Voltage	Wattage	ECE	Cap	Application	Colour	Pack Qty	Barcode	Ref	Pack Qty	Barcode
RU512PCB	12V	2CP		P.C.B 10mm	☉		10 x 1	5011274151218			
RU512TR	12V	2CP		B12.3d 10mm	☉		10 x 1	5011274151225			
RU512WB	12V	2W		Kw2.1x9.5D	☉	White base	10 x 1	5011274151232			
RU566	12V	21/4W	P21/4W	BAZ15d	☉☉☉		10 x 1	5011274156619	RW566	10 x 1	5011274156626
RU580	12V	21/5W	W21/5W	W3x16q	☉☉☉☉		10 x 1	5011274158064	RW580	10 x 1	5055175202525
RU581	12V	21W	PY21W	BAU15s	☉☉	Amber	10 x 1	5011274158118	RW581	10 x 1	5011274158132
RU582	12V	21W	W21W	W3x16d	☉☉☉☉☉		10 x 1	5011274158262			
RU585	12V	21W	WY21W	W3x16d	☉☉	Amber	10 x 1	5011274158514	RW585	10 x 1	5011274158521
RU64122	12V	3W		B10D	☉	Brown base	10 x 1	5011274164126			
RU64124	12V	5W		B10D	☉	Black base	10 x 1	5011274164133			
RU643	12V	2.2W		BA9s	☉		10 x 1	5011274164317			
RU780	12V	21/5W	PR21/5W	BAW15d	☉☉☉	Red	10 x 1	5055175220581			
RU782	12V	21W	PR21W	BAW15s	☉☉☉	Red	10 x 1	5055175220598			
RU955	12V	16W	W16W	W2.1x9.5d T15	☉☉☉		10 x 1	5011274195526			
RU987	12V	2.2W		E10/13	☉		10 x 1	5011274198718	RW987	10 x 1	5011274198725
RU989	12V	5W		BA9s	☉☉		10 x 1	5011274198916	RW989	10 x 1	5011274198923

24V Blister Pack Headlamp and Auxiliaries

Part No	Voltage	Wattage	ECE	Cap	Application	Colour	Pack Qty	Barcode
RW149	24V	5W	R5W	BA15s	☉☉☉		10 x 1	5011274114946
RW150	24V	5W	R5W	BA15d	☉☉☉		10 x 1	5011274115012
RW241	24V	21W	P21W	BA15s	☉☉☉☉☉☉		10 x 1	5011274124113
RW242	24V	5W	C5W	S8.5d 11 x 38mm	☉☉☉		10 x 1	5011274124212
RW246	24V	10W	R10W	BA15s	☉☉☉		10 x 1	5055175230078
RW249	24V	4W	T4W	BA9s	☉☉☉		10 x 1	5011274124915
RW346	24V	21W	P21W	BA15d	☉☉☉☉☉☉		10 x 1	5011274134617
RU466	24V	70W	H1	P14.5s	☉☉☉☉☉☉		10 x 1	5055175230108
RU474	24V	70W	H7	PX26d	☉☉☉☉☉☉		10 x 1	5055175230061
RU475	24V	75/70W	H4	P43t	☉☉☉☉☉☉		10 x 1	5011274323073
RW505	24V	3W	W3W	W2.1x9.5d	☉		10 x 1	5055175230085
RW507	24V	5W	W5W	W2.1x9.5d	☉		10 x 1	5055175230092
RW508	24V	1.2W		W2x4.6d	☉		10 x 1	5011274150815
RW508T	24V	1.2W		B8.5d	☉	Grey base	10 x 1	5011274150822
RW588	24V	21W	PY21W	BAU15s	☉	Amber	10 x 1	5055175230115

TruckMaster Bulbs

The Ring TruckMaster Heavy Duty Long Life (HDLL) bulb range has been phased out. If you are looking for an OE replacement we suggest the OSRAM TRUCKSTAR PRO range as the best alternative. For more information contact the Customer Service Team or visit www.osram.co.uk/truck



Vehicle Lighting



Essentials Range

A range of fast moving bulbs and consumables for forecourts

- Bulbs are one of the highest profit makers in the auto aftermarket
- Essential distress purchase and expected to be stocked in a forecourt
- Planogram service available



50cm wide x 56cm high

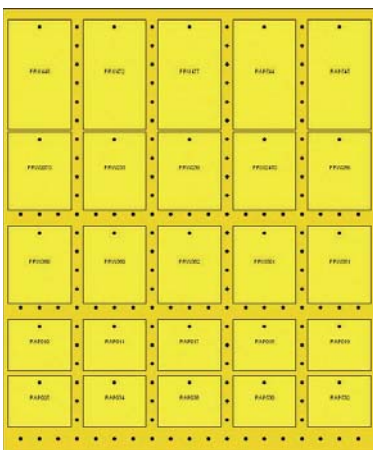

A = 8.5cm x 7cm

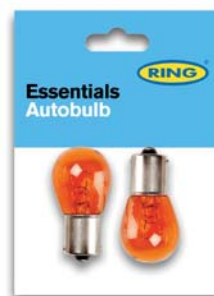

B = 8.5cm x 10.5cm



C = 8.5cm x 14.7cm

*Headlamps only

Essentials Bulbs

Part Number	Voltage	Wattage	ECE	Cap	Applications	Colour	Pack size	Pack Qty	Barcode
FRU448	12V	55W	H1	P14.5s			C	10 x 1	5055175210438
FRU472	12V	60/55W	H4	P43t			C	10 x 1	5055175210414
FRU477	12V	55W	H7	PX26d			C	10 x 1	5055175210421
FRW207	12V	5W	R5W	BA15s			B	10 x 1	5055175210476
FRW233	12V	4W	T4W	BA9s			B	10 x 1	5055175210520
FRW239	12V	5W	C5W	S8.5d 11x38mm			B	10 x 1	5055175210506
FRW245	12V	10W	R10W	BA15s			B	10 x 1	5055175210490
FRW286	12V	1.2W		W2x4.6d			B	10 x 1	5055175210513
FRW380	12V	21/5W	P21/5W	BAY15d			B	10 x 1	5055175210452
FRW382	12V	21W	P21W	BA15s			B	10 x 1	5055175210445
FRW501	12V	5W	W5W	W2.1x9.5d			B	10 x 1	5055175210469
FRW581	12V	21W	PY21W	BAU15s		Amber	B	10 x 1	5055175210483

FRW= Twin Blister Pack

FRU= Single Blister Pack

Essentials Consumables

A range of fast moving automotive consumables including fuses, tape and connectors

Part Number	Description	Pack size	Pack Qty	Barcode
RAP010	Assorted Blade Fuses 15, 20, 25, 30 Amp	A	10 x 1	5011274901011
RAP011	Assorted Blade Fuses 3, 5, 7.5, 10 Amp	A	10 x 1	5011274901110
RAP017	Assorted Mini Blade Fuses 2, 4, 5, 7.5 Amp	A	10 x 1	5011274901714
RAP018	Assorted Mini Blade Fuses 10, 15, 20, 25 Amp	A	10 x 1	5055175210537
RAP019	Cable Connectors	A	10 x 1	5055175210544
RAP025	Assorted Ceramic Fuses, 5, 8, 16, 25 Amp	A	10 x 1	5011274902513
RAP034	Assorted Glass Fuses 10, 15, 25, 35 Amp	A	10 x 1	5011274903411
RAP038	Assorted Mains 240V Fuses, 3, 5, 13 Amp	A	10 x 1	5011274903817
RAP530	Mirror Fixing Pads	A	10 x 1	5011274953010
RAP532	Plastic Valve Caps	A	10 x 1	5011274953218
RAP544	Assorted Hose Clips	D	10 x 1	5011274954413
RAP545	PVC Insulation Tape	D	10 x 1	5011274954512



Vehicle Lighting

Bulb Kits 30



12V Auto Bulb Kits

- A compact kit that fits into the glove compartment
 - All bulbs are E approved as required
 - Mandatory in many European countries
 - Range covers all popular vehicle types
 - All bulbs can be replaced
 - Contains bulbs for headlamps and exterior lighting
 - UV cut headlamp bulbs suitable for plastic headlamps
- Don't leave home without one!



Universal Multi Headlamp 12V Auto Bulb Kit

- Suitable for vehicles fitted with H4, H1 or H7 headlamp bulbs
- 3 headlamp bulbs
- 12 additional bulbs
- 4 blade fuses
- Transferable from vehicle to vehicle



Mini 12V Auto Bulb Kit

- Compact kit for easy storage
- Contains major bulbs for exterior lighting plus fuses
- Universal kit contains 3 headlamps



*Headlamps only

Universal Standard 12V Auto Bulb Kits

Part Number	Suitable For Vehicles Fitted With:	Headlamp Bulbs	Additional Bulbs	Fuses	Barcode
BU007	H4 (R472) Headlamp Bulbs	1	9	3	5011274000745
BU008	H1 (R448) Headlamp Bulbs	1	9	3	5011274000806
BU077	H7 (R477) Headlamp Bulbs	1	9	3	5011274007706
BU031	HB3 (R9005) Headlamp Bulbs	1	10	3	5011274031114
BU041	HB4 (R9006) Headlamp Bulbs	1	10	3	5011274041113
BU042	HB3 (R9005) & HB4 (R9006) Headlamp Bulbs	2	10	3	5011274042226
BU072	H4 (R472) Headlamp Bulbs plus wedge base bulbs for Japanese vehicles	1	10	3	5011274072223
BU073	H7 (R477) Headlamp Bulbs plus wedge base bulbs for Japanese vehicles	1	10	3	5011274073336
BU078	H7 (R477) & H1 (R448) Headlamp Bulbs	2	10	3	5011274078881
BU079	H7 (R477) & HB3 (R9005) Headlamp Bulbs	2	10	3	5011274079994
BU080	H7 (R477) & H11 (R711) Headlamp Bulbs	2	6	2	5055175234861
BU087	H4 (R472) & H1 (R448) Headlamp Bulbs	2	10	3	5011274087777

Mini 12V Auto Bulb Kit

BU050	H4 (472) Headlamp Bulb	1	5	2	5055175219042
BU051	H1 (448) Headlamp Bulb	1	5	2	5055175219059
BU052	H7 (477) Headlamp Bulb	1	5	2	5055175219066
BU053	H7/H1 (477/448)	2	5	2	5055175219073
BU054	H4 (R472) & H1 (R448) & H7 (R477) Headlamp Bulbs	3	5	3	5055175219080

Universal Multi Headlamp 12V Auto Bulb Kit

BU027	H4 (R472) & H1 (R448) & H7 (R477) Headlamp Bulbs	3	12	4	5055175215631
-------	--	---	----	---	---------------

Vehicle Lighting









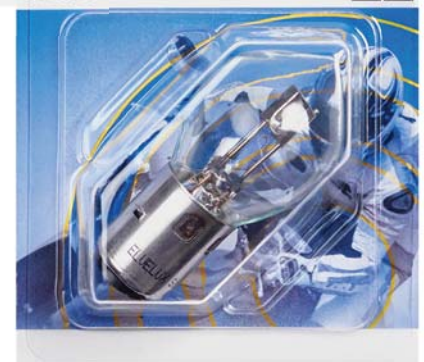
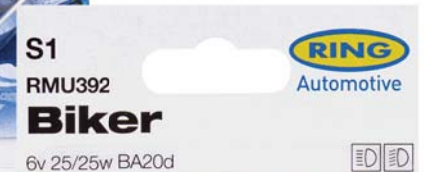





















Biker Bulbs

For over 40 years Ring has been pushing the boundaries of motorcycle lighting. We were the first company to produce a halogen bulb that put up to 100% more light on the road XenonMax. Today it is Xenon150 that sets the standard.

For a motorcyclist, being seen is equally important as seeing. We have designed a full range of lighting solutions to provide the safety your customer needs as well as the styling they are looking for.



Blister

Part Number	Voltage	Wattage	ECE	Cap	Application	Colour	Barcode	Ref	Barcode
RMU3625	6V	25/25W		PX15d			5055175211572	R3625	5055175213118
RMU392	6V	25/25W	S1	BA20D			5055175211596	R392	5011274053925
RMU393	6V	35/35W	S2	BA20D			5055175211602	R393	5011274039332
RMU3603	12V	25/25W		PX15d			5055175211565	R3603	5055175213101
RMU394	12V	25/25W	S1	BA20D			5055175211619	R394	5055175213125
RMU395	12V	35/35W	S2	BA20D			5055175211626	R395	5011274039592
RMU418	12V	23W		BA9s		Amber	5055175213583	R418	5055175212555
RMU448	12V	55W	H1	P14.5s			5055175211725	R448EQ	5011274041824
RMU459	12V	35/35W	HS1	PX43t			5055175211657	R459	5055175210902
RMU472	12V	60/55W	H4	P43t			5055175211732	R472	5011274047207
RMU477	12V	55W	H7	PX26d			5055175211749	R477	5011274047702
RMU610	12V	15W	S3	P26S			5055175211671	R610	5055175212425
RMU613	12V	20W		P26S			5055175211688	R613	5055175213156
RMU711	12V	55W	H11	PGJ19-2			5055175213590	R711	5011274071165
RMU7027	12V	35/35W		P15D-3			5055175211695	R7027	5055175213163
RMU7028	12V	45/40W		P15D-3			5055175211701	R7028	5055175213170
RMW207S	12V	5W	R5W	BA15s			5055175211794	207S	5011274021764
RMW233	12V	4W	T4W	BA9s			5055175211800	R233	5011274023362
RMW239	12V	5W	C5W	S8.5d			5055175211817	R239	5011274023966
RMW245S	12V	10W	R10W	BA15s			5055175211824	R245S	5011274024574
RMW380	12V	21/5W	P21/5W	BAY15d			5055175211831	R380	5011274038007
RMW382	12V	21W	P21W	BA15s			5055175211848	R382	5055175211848
RMW501	12V	5W	W5W	W2.1x9.5d			5055175211855	R501	5011274405160
RMW581	12V	21W	PY21W	BAU15s		Amber	5055175211862	R581	5011274058166
RMU293	6V	4W	T4W	BA9s			5055175211558	R293	5011274029363
RMU384	6V	21/5W	P21/5W	BAY15d			5055175211589	R384	5011274038465
RMU286	12V	1.2W		W2x4.6d			5055175211718	R286	5011274028671
RMU504	12V	3W	W5W	W2.1x9.5d			5055175211756	R504	5011274050467
RMU589	12V	10W	RY10W	BA15s		Amber	5055175211664	R589	5055175213200

Vehicle Lighting



Panel Bulb Kits

- Full colour selector guide
- All popular references
- Durable, resealable compartment box
- Product locator for easy and accurate replenishment
- Available in:
 - RPB121 12V Standard
 - RPB243 24V Standard

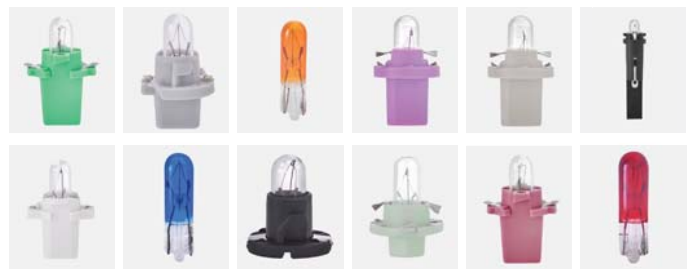

12V Standard Panel Bulb Kit RPB121

Contents

Part Number	Qty	Part Number	Qty
R509TMOR	2	R509TMBK	3
R509TMBE	2	R509TMGR	2
R509TMLB	3	R509TOR	2
R509T	10	R509TGR	3
R509TBBK	2	R509TBWH	2
R509TWGR	2	R509TWGY	2
R509TDBK	2	R509TEBK	2
R509THGY	3	R286	10
R286A	3	R286B	3
R286G	5	R286R	3
R501A	5		

24V Standard Panel Bulb Kit RPB243

Contents

Part Number	Qty	Part Number	Qty
R508TMRE	2	R508TMGR	2
R508TBR	4	R508T	10
R508TBGY	4	R1471	10
R1791	10	R6929	2
R508TWBR	2	R508TCWH	2
R508TCTR	2	R508A	2
R508B	2	R508G	2
R508R	2	R508TUWH	2
R508TWH	2	R86021003	2
R86028166	2	R8328	2
R86024918	2		

Bulb Connectors

- Direct replacement

Ceramic Bulb Holders



Part Number RBH001
Bulb Fitment H1/H3
 P14.5s/PK22s
Cable Rating 8.2A
Cable Length 130mm
 Straight cable exit



Part Number RBH002
Bulb Fitment H1/H3
 P14.5s/PK22s
Cable Rating 8.2A
Cable Length 130mm
 Angled cable exit



Part Number RBH003
Bulb Fitment H4
 P43t/P45t
Cable Rating 8.2A
Cable Length 130mm
 Straight cable exit

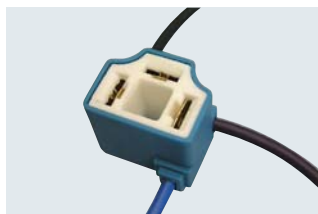

Part Number RBH004
Bulb Fitment H4
 P43t/P45t
Cable Rating 8.2A
Cable Length 130mm
 Angled cable exit

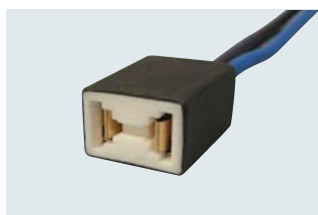

Part Number RBH005
Bulb Fitment H7
 PX26d
Cable Rating 8.2A
Cable Length 130mm
 Straight cable exit

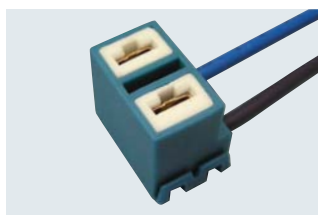

Part Number RBH006
Bulb Fitment H7
 PX26d
Cable Rating 8.2A
Cable Length 130mm
 Angled cable exit



Part Number RBH007
Bulb Fitment H11
 PGJ19-2
Cable Rating 8.2A
Cable Length 130mm
 Straight cable exit



Part Number RBH008
Bulb Fitment 9004 /9007
 P29t/Px29t
Cable Rating 8.2A
Cable Length 130mm
 Straight cable exit



Part Number RBH009
Bulb Fitment 9005
 P20d
Cable Rating 8.2A
Cable Length 130mm
 Straight cable exit



Part Number RBH010
Bulb Fitment 9006
 P22d
Cable Rating 8.2A
Cable Length 130mm
 Straight cable exit

Standard Bulb Holders



Part Number RBH011
Bulb Fitment BA15D
Cable Rating 8.2A
Cable Length 130mm
 Straight cable exit



Part Number RBH012
Bulb Fitment BA15S
Cable Rating 8.2A
Cable Length 130mm
 Straight cable exit

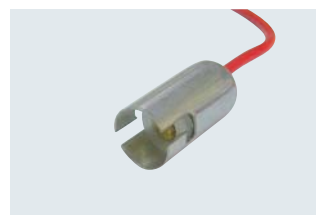

Part Number RBH013
Bulb Fitment BA9S
Cable Rating 8.2A
Cable Length 130mm
 Straight cable exit



Part Number RBH014
Bulb Fitment BAY15D
Cable Rating 8.2A
Cable Length 130mm
 Straight cable exit

Vehicle Lighting

Single Boxed Stands

Ring provides your customers with a range of solutions to having Autobulbs at the point of installation. Carrying the fast moving references, these wall mounted stands safely contain the stock in the workshop right next to the job in hand.



BU194

12V Bulb Stand Complete with Stock



Ref	Qty	Ref	Qty
R472	6	R435	4
R477	16	RB272	5
R448	11	RB955	5
RB380	11	RB269	5
RB382	11	RB264	5
RB581	11	RB233	5
RB566	4	RB245S	5
RB580	4	RB504	5
RB582	4	RB501A	5
RB585	4	RB501	14
R434	4	RB239	14
RB335	4	RB207S	14
RB343	4	RB286	14

Total: 194

BU175

12V Bulb Stand Complete with Stock



Ref	Qty	Ref	Qty
RB207S	13	RB382	10
RB239	13	RB566	10
RB245S	13	RB580	10
RB286	13	RB581	10
RB501	13	RB582	10
RB501A	13	R448	10
RB955	13	R477	8
RB380	10	R472	6

Total: 175

BU274

24V Bulb Stand Complete with Stock



Ref	Qty	Ref	Qty
RB149	13	RB290	10
RB150	13	RB294	10
RB242	13	RB346	10
RB246	13	R535	10
RB249	13	R466	10
RB505	13	R460	10
RB507	13	R474	7
RB241	10	R475	6

Total: 174

Marketing Support

For mechanics, knowledge equals confidence.

Therefore we set out to provide as much technical support as a mechanic will require. Our comprehensive bulb literature is constantly updated to ensure mechanics have access to the latest information. We provide work outs and training events to ensure mechanics maximise their sales of bulbs.

E Marking and Bulb Quality

Introduction

It's a fact the simple Autobulb is a safety critical component of any vehicle on the road today. Often overlooked, it's a key part of providing the right light ahead on a dark road or warning other road users a driver is braking or about to change direction. As it is vital to operate safely the bulbs must be manufactured to International Standards.

ECE Regulation 37

The Standard in ECE Regulation 37 meets commonly adhered to the "37" mark ECE Regulation 37 details exact specifications that cover the light output, filament geometry, voltage and wattage and the size and shape of the bulb.

How can I tell if a bulb meets ECE Regulation 37?

It should be marked with ALL the following information:

1. The trade name or mark of the manufacturer.
2. The rated voltage, typically 12V for passenger cars and 24V for commercial vehicles.
3. The international designation for the lamp e.g. W21W.
4. The rated wattage of the lamp including any dual filaments e.g. 21W or 21/5W. This is not required if the international designation identifies the wattage.
5. The approval mark in accordance with the specification for its size and shape (also Fig. 1).

This consists of the following:

1. The designated E number Reg. 2(11) in a rectangular box followed by a unique 3 digit code. This can only be applied to one lamp type for each manufacturer. This identifies the manufacturer.
2. In the case of a halogen bulb which has to meet the requirements of the UV cut-off specification it may be marked with a U.

The above approval mark affixed to a filament lamp indicates the lamp has been approved in the United Kingdom (U.K.) under the approval code A1. The first character of the approval code indicates the approval was granted in accordance with the requirements of ECE Regulation No. 37 as amended by the 02 and 03 series of amendments.

The Legal Requirements

It is illegal to fit light assemblies that carry their own performance approval numbered with bulbs that are not ECE approved (1998 Road Vehicle Lighting Regulations). In addition, it is also illegal to stock or offer these bulbs for sale in the UK (Placement Lamp for Vehicles (Safety Regulation 1992)). The standard for Gas Discharge light sources is ECE Reg. 98.

Vehicle Lighting

Bulb Guide

Diagram No. 1

Category Description

Typical Usage

Halogen Headlamps



Bulb Image

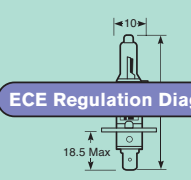

ECE Regulation Diagram

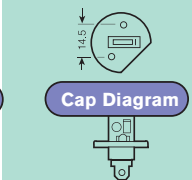

Cap Diagram

Cap Type

ECE No.

H1

Cross Reference Info

P14.5s

LAMP NO	VOLTS	WATTS	ECE NO	DESCRIPTION	PHILIPS	OSRAM	GE / TUNGSRAM
© R448	12	55	H1		12258	64150	50310/1U

Key to Colours

Bulb type

- EQ bulb
- Long Life
- Extra Life
- Xenon4000 (4000K +30%)
- Xenon5000 (5000K +50%)
- Xenon100 (+100%)
- Xenon150 (+150%)
- Xenon200 (+200%)
- RallySport*
- SportzBlue*
- Ring LED
- Rapid Response
- Heavy Duty
- Ice Blue

Bulb colour

- Amber
- Silver Amber
- Red
- Silver Red
- Blue
- Green
- Purple
- Multicolour

Part Number / Packaging Type

- RX Upgrade Twin Pack
- RB Single Boxes Auxiliary
- RU Single Blister
- RW Twin Blister
- R Auxiliary 10 Way
- R Halogen Single Box

Cap References

- SCC Single Centre Contact
- MCC Miniature Centre Contact
- MES Miniature Edison Screw
- OSP Offset Pin
- SBC Small Bayonet Cap
- ES Edison Screw
- BC Bayonet Cap
- SES Small Edison Screw
- LES Lilliput Edison Screw

*Products are not ECE approved and are for off-road use only.

Halogen Headlamps







1				H1			
				P14.5s			
LAMP NO	VOLTS	WATTS	ECE NO	DESCRIPTION	PHILIPS	OSRAM	GE / TUNGSRAM
R465	6	55			6258	64168	
Ⓢ R448	12	55	H1		12258PR	64150	50310/1U
Ⓢ R448EQ	12	55	H1	EQ Bulb	12258PR	64150S	
Ⓢ R448LL	12	55	H1	Long life	12258LL/12258LLECO	64150ULT	50310DPU
Ⓢ RX1048	12	55	H1	Xenon100		64150NBS	50310XU
Ⓢ RX1548	12	55	H1	Xenon150		64150NL	
Ⓢ RX4048	12	55	H1	Xenon4000	12258WHV	64150CBN	50310SBU
Ⓢ RX5048	12	55	H1	Xenon5000			50310SUP
RX481	12	100		RallySport	12454RA	62200SBP	52140U
RX668	12	80		SportzBlue	12425RA		
Ⓢ R466	24	70	H1		13258	64155	50320/1U
Ⓢ R466HD	24	70	H1	Heavy Duty			
R493	24	100					

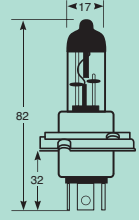

2				H2			
				X511			
LAMP NO	VOLTS	WATTS	ECE NO	DESCRIPTION	PHILIPS	OSRAM	GE / TUNGSRAM
R479	12	55			12311	64173	50410U
R482	24	70			13311	64175	50420U
R494	24	100					

3				H3			
				PK22s			
LAMP NO	VOLTS	WATTS	ECE NO	DESCRIPTION	PHILIPS	OSRAM	GE / TUNGSRAM
R456	6	15					
R457	6	25					
Ⓢ R455	6	55	H3		6336	64147	
R445	12	10					
R446	12	20					
R462	12	35					
Ⓢ R453	12	55	H3		12336	64151	50340U
Ⓢ R453LL	12	55	H3	Long life	12336LL / 12336LLECO		50340DPU
R449	24	35					
R444	24	50					
Ⓢ R460	24	70	H3		13336	64156	50350U
Ⓢ R460HD	24	70	H3	Heavy Duty	13336MD	64156TSP	50350U_HDL
R495	24	100			13628RA		50400U
R441	36	45					
R442	48	45					
R443	80	55					

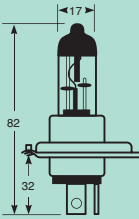
Vehicle Lighting

								<h2>H4</h2>	
						<h3>P45t</h3>			
LAMP NO	VOLTS	WATTS	ECE NO	DESCRIPTION	PHILIPS	OSRAM	GE / TUNGSRAM		
R012	12	60/55			12475	64198SB	52070U		
Ⓞ R904	12	45/40	R2		12475		52950		
R024	24	75/70				64199			
R497	24	100/80					52730U		

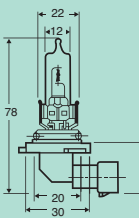
								<h2>H4</h2>	
						<h3>P43t</h3>			
LAMP NO	VOLTS	WATTS	ECE NO	DESCRIPTION	PHILIPS	OSRAM	GE / TUNGSRAM		
R910	6	35/35	HS1						
Ⓞ R905	6	60/55	H4						
Ⓞ R459	12	35/35	HS1		12636	64185	50470U		
R911	12	45/40							
R9003	12	60/55	HB2			9003L			
Ⓞ R472	12	60/55	H4		12342PR	64193	50440HU		
Ⓞ R472EQ	12	60/55	H4	EQ Bulb	12342PR	94193			
Ⓞ R472LL	12	60/55	H4	Long life	12342LL/12342LLECO	64193ULT	50440DPU		
Ⓞ R472HD	12	60/55	H4	Heavy Duty	12342HD				
Ⓞ RX1072	12	60/55	H4	Xenon100		64193NBS / 64193NR1	50440SXU		
Ⓞ RX1572	12	60/55	H4	Xenon150	12342RV	64193NL	50440NXNU		
Ⓞ RX2072	12	60/55	H4	Xenon200	12342RGTS2	64193NB200			
Ⓞ RX4072	12	60/55	H4	Xenon4000					
Ⓞ RX5072	12	60/55	H4	Xenon5000		64193NL	50440SUP		
RX484	12	100/80		RallySport	12569RA	62204SBP	52100U		
RX684	12	100/80		SportzBlue		64193NR			
Ⓞ R475	24	75/70	H4		13342	64196	50450U		
Ⓞ R475HD	24	75/70	H4	Heavy Duty	13342MD	64196TSP			
R496	24	100/80			24569RA	62248	52710U		
R498	24	130/90				62249	52660		

								<h2>HB3</h2>	
						<h3>P20d</h3>			
LAMP NO	VOLTS	WATTS	ECE NO	DESCRIPTION	PHILIPS	OSRAM	GE / TUNGSRAM		
Ⓞ RX1005	12	60	HB3	Xenon100		9005NBU	53060XU		
Ⓞ R9005	12	60	HB3		9005PR	9005	53060U		

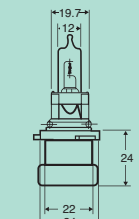
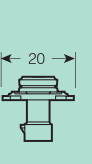
								<h2>HB3A</h2>	
						<h3>P20d</h3>			
LAMP NO	VOLTS	WATTS	ECE NO	DESCRIPTION	PHILIPS	OSRAM	GE / TUNGSRAM		
Ⓞ R9005XS	12	60	HB3A		-	9005XS			

					<h1>HB4</h1>		
						P22d	
LAMP NO	VOLTS	WATTS	ECE NO	DESCRIPTION	PHILIPS	OSRAM	GE / TUNGSRAM
Ⓒ R9006	12	51	HB4		9006PR	9006	53070U
Ⓒ RX1006	12	51	HB4	Xenon100		9006NBU	53070SXU

					<h1>HB4A</h1>		
						P22d	
LAMP NO	VOLTS	WATTS	ECE NO	DESCRIPTION	PHILIPS	OSRAM	GE / TUNGSRAM
Ⓒ R9006XS	12	51	HB4A			9006XS	

					<h1>H7</h1>		
						PX26d	
LAMP NO	VOLTS	WATTS	ECE NO	DESCRIPTION	PHILIPS	OSRAM	GE / TUNGSRAM
Ⓒ R477	12	55	H7		12972PR	64210	58520U
Ⓒ R477LL	12	55	H7	Long life	12972LL/12972LLECO	64210ULT	58520DPU
Ⓒ R477EL	12	55	H7	Extra life			
Ⓒ R477EQ	12	55	H7	EQ Bulb	12972PR		58520U
Ⓒ R477HD	12	55	H7	Heavy Duty	13972ML		
Ⓒ RX1077	12	55	H7	Xenon100		64210NBS / 64210NR1	58520SXU
Ⓒ RX1577	12	55	H7	Xenon150	12972RV	64210NL	58520NXNU
Ⓒ RX2077	12	55	H7	Xenon200	12972RGTS2	64210NB200	
Ⓒ RX4077	12	55	H7	Xenon4000	12972WHV	64210CBN	
Ⓒ RX5077	12	55	H7	Xenon5000			58520SUP
RX464	12	100	H7	RallySport	12035RA	62261SBP	
RX664	12	80	H7	SportzBlue		62210CBB	
Ⓒ R474	24	70	H7		13972	64215	58521U
Ⓒ R474HD	24	70	H7	Heavy Duty	13972MD	64215TSP	58521HDLU
R454	24	100					

					<h1>H8</h1>		
						PGJ19-1	
LAMP NO	VOLTS	WATTS	ECE NO	DESCRIPTION	PHILIPS	OSRAM	GE / TUNGSRAM
Ⓒ R708	12	35	H8		12360	64212	53090HU

					<h1>H8B</h1>		
						PGJY19-1	
LAMP NO	VOLTS	WATTS	ECE NO	DESCRIPTION	PHILIPS	OSRAM	GE / TUNGSRAM
Ⓒ R920	12	35	H8B		-	64242	

Vehicle Lighting

13

H9

PGJ19-5

LAMP NO	VOLTS	WATTS	ECE NO	DESCRIPTION	PHILIPS	OSRAM	GE / TUNGSRAM
© R709	12	65	H9		12361	64213	53100U

14

H9B

PGJY19-5

LAMP NO	VOLTS	WATTS	ECE NO	DESCRIPTION	PHILIPS	OSRAM	GE / TUNGSRAM
© R919	12	65	H9B		-	64243	

15

H10

PY20d

LAMP NO	VOLTS	WATTS	ECE NO	DESCRIPTION	PHILIPS	OSRAM	GE / TUNGSRAM
© R710	12	42	H10		9145	9145	53080U

16

H11

PGJ19-2

LAMP NO	VOLTS	WATTS	ECE NO	DESCRIPTION	PHILIPS	OSRAM	GE / TUNGSRAM
© R711	12	55	H11		12362PR	64211	53110HU
© RX1011	12	55	H11	■ Xenon100		64211NBS / 64211NR1	53110SXU
© RX1511	12	55	H11	■ Xenon150		64211NL	
© RX2011	12	55	H11	■ Xenon200		64211NB200	
© RX5011	12	55	H11	■ Xenon5000			53110SUP
© R458	24	70	H11		24362MD		
© R458HD	24	70	H11	■ Heavy Duty	24362MD	64216TSP	58521HDLU

17

H12

PZ20d

LAMP NO	VOLTS	WATTS	ECE NO	DESCRIPTION	PHILIPS	OSRAM	GE / TUNGSRAM
© R712	12	53	H12				

18											H13
											P26.4t
LAMP NO	VOLTS	WATTS	ECE NO	DESCRIPTION	PHILIPS	OSRAM	GE / TUNGSRAM				
© R9008	12	60/55	H13		9008	9008					

19											H15
											PGJ23t-1
LAMP NO	VOLTS	WATTS	ECE NO	DESCRIPTION	PHILIPS	OSRAM	GE / TUNGSRAM				
© R715	12	55/15	H15		12580	64176					

20											H16
											PGJ19-3
LAMP NO	VOLTS	WATTS	ECE NO	DESCRIPTION	PHILIPS	OSRAM	GE / TUNGSRAM				
© R716	12	19	H16		12366	64219L					

21											H18
											PY26d
LAMP NO	VOLTS	WATTS	ECE NO	DESCRIPTION	PHILIPS	OSRAM	GE / TUNGSRAM				
© R718	12	65	H18		12643	64180L					

22											HIR2
											PX22d
LAMP NO	VOLTS	WATTS	ECE NO	DESCRIPTION	PHILIPS	OSRAM	GE / TUNGSRAM				
© R9012	12	55	HIR2		9012	9012	54430U				
© RX1512	12	55	HIR2	■ Xenon150	9012XVP						

Vehicle Lighting

Xenon HID



23							D1S
							PK32d-2
LAMP NO	VOLTS	WATTS	ECE NO	DESCRIPTION	PHILIPS	OSRAM	GE / TUNGSRAM
© R85402	85	35	D1S		85415V1	66140	53620

24							D2S
							P32d-2
LAMP NO	VOLTS	WATTS	ECE NO	DESCRIPTION	PHILIPS	OSRAM	GE / TUNGSRAM
© R85122	85	35	D2S		85122V1	66240	53500

25							D2R
							P32d-3
LAMP NO	VOLTS	WATTS	ECE NO	DESCRIPTION	PHILIPS	OSRAM	GE / TUNGSRAM
© R85126	85	35	D2R		85126V1	66250	53510

26							D3S
							PK32d-5
LAMP NO	VOLTS	WATTS	ECE NO	DESCRIPTION	PHILIPS	OSRAM	GE / TUNGSRAM
© R42302	42	35	D3S		42403V1	66340	53660U

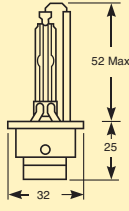
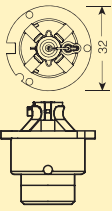

27							D3R
							PK32d-6
LAMP NO	VOLTS	WATTS	ECE NO	DESCRIPTION	PHILIPS	OSRAM	GE / TUNGSRAM
© R42306	42	35	D3R		42306V1	66350	

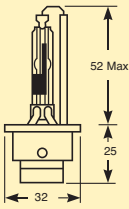
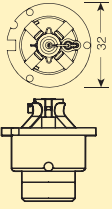
28								D4S	
								P32d-5	
LAMP NO	VOLTS	WATTS	ECE NO	DESCRIPTION	PHILIPS	OSRAM	GE / TUNGSRAM		
© R42402	42	35	D4S		42402VI	66440	53670U		

29								D4R	
								P32d-6	
LAMP NO	VOLTS	WATTS	ECE NO	DESCRIPTION	PHILIPS	OSRAM	GE / TUNGSRAM		
© R42406	42	35	D4R		42406	66450			

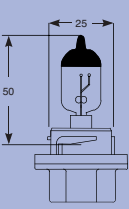

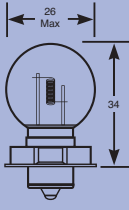
Motorcycle Headlamps

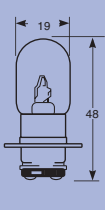
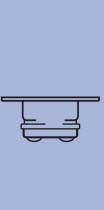

30								HS5	
								P23t	
LAMP NO	VOLTS	WATTS	ECE NO	DESCRIPTION	PHILIPS	OSRAM	GE / TUNGSRAM		
© R929	12	35/30	HS5						

31								S3	
								P26s	
LAMP NO	VOLTS	WATTS	ECE NO	DESCRIPTION	PHILIPS	OSRAM	GE / TUNGSRAM		
© R609	6	15	S3						
© R610	12	15	S3		12008				
R613	12	20							

32								PX15D	
LAMP NO	VOLTS	WATTS	ECE NO	DESCRIPTION	PHILIPS	OSRAM	GE / TUNGSRAM		
R3625	6	25/25							
R3603	12	25/25							

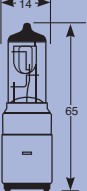
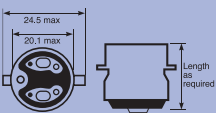

Vehicle Lighting



33									
							P15D-3		
LAMP NO	VOLTS	WATTS	ECE NO	DESCRIPTION	PHILIPS	OSRAM	GE / TUNGSRAM		
R7027	12	35/35							
R7028	12	45/40							

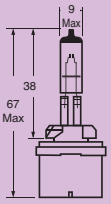

34									
							S2		
LAMP NO	VOLTS	WATTS	ECE NO	DESCRIPTION	PHILIPS	OSRAM	GE / TUNGSRAM		
© R417	12	35/35	S2			64327			

Special Headlamps

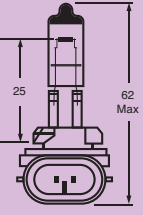

35									
							H27W1		
LAMP NO	VOLTS	WATTS	ECE NO	DESCRIPTION	PHILIPS	OSRAM	GE / TUNGSRAM		
© R880	12	27	H27W/1		12059	880	54480U		

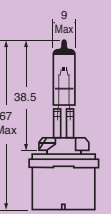
36									
							H27W2		
LAMP NO	VOLTS	WATTS	ECE NO	DESCRIPTION	PHILIPS	OSRAM	GE / TUNGSRAM		
© R881	12	27	H27W/2		12060	881	54490U		

37									
							H27W1		
LAMP NO	VOLTS	WATTS	ECE NO	DESCRIPTION	PHILIPS	OSRAM	GE / TUNGSRAM		
R885	12	50							
R887	12	50		■ Long life					

38							PGJ13	
				LAMP NO	VOLTS	WATTS	ECE NO	DESCRIPTION
	R894	12	37.5					
	R886	12	50					

39								P29t/PX29t
					LAMP NO	VOLTS	WATTS	ECE NO
	R9004	12	65/45	(HB1)		9004	9004	9004
	R9007	12	65/55	(HB5)		9007	9007	

40							P30/22L	
				LAMP NO	VOLTS	WATTS	ECE NO	DESCRIPTION
	R964	12	45/55					
	R965	12	65/65					

41							H3r	
				LAMP NO	VOLTS	WATTS	ECE NO	DESCRIPTION
	R961	12	55					
								PK22sr

42							MH6R	
				LAMP NO	VOLTS	WATTS	ECE NO	DESCRIPTION
	R962	12	55/40					
								P30t-40

Vehicle Lighting

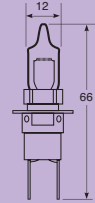
43									H3c
									P22d/5
LAMP NO	VOLTS	WATTS	ECE NO	DESCRIPTION	PHILIPS	OSRAM	GE / TUNGSRAM		
R447	12	55							
R960	12	55 (85)							

Asymmetric and Standard Headlamps

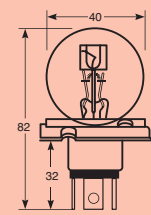
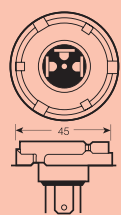
44										R2
										P45t ASY UEC
LAMP NO	VOLTS	WATTS	ECE NO	DESCRIPTION	PHILIPS	OSRAM	GE / TUNGSRAM			
Ⓢ R423	6	45/40	R2		6620	7950	1926			
Ⓢ R410	12	45/40	R2		12620	64183	1931			
R416	12	60/60								
Ⓢ R429	24	55/50	R2		13620	7952	1937			

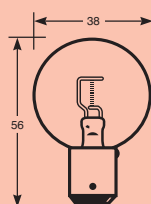
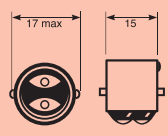
45										BA15d (SBC)
LAMP NO	VOLTS	WATTS	ECE NO	DESCRIPTION	PHILIPS	OSRAM	GE / TUNGSRAM			
R005	12	36			12221	7468				

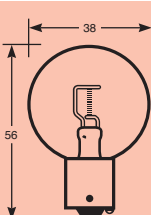
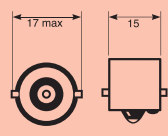
46										BA15s (SCC)
LAMP NO	VOLTS	WATTS	ECE NO	DESCRIPTION	PHILIPS	OSRAM	GE / TUNGSRAM			
R002	12	36			12222					
R621	24	36								
R623	24	48			13241	7668				

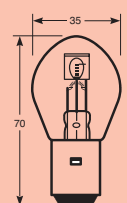
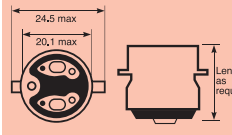
47										S1 S2
										BA20d (Bosch)
LAMP NO	VOLTS	WATTS	ECE NO	DESCRIPTION	PHILIPS	OSRAM	GE / TUNGSRAM			
Ⓢ R392	6	25/25	S1		6718	7323	91210			
Ⓢ R393	6	35/35	S2		7008	7130	91220			
Ⓢ R394	12	25/25	S1		12718	64326				
Ⓢ R395	12	35/35	S2		12728	7327	91221			
R396	12	45/40			12748	7351	91231			
R398	24	45/40					91232			

British Pre-Focus Headlamps



48				PHILIPS	OSRAM 7447	P36s Axial
						LAMP NO
	R185	12	48			

49				PHILIPS	OSRAM	P36d Transverse
						LAMP NO
	R330	24	44			

50				PHILIPS	OSRAM	P36s Transverse
						LAMP NO
	R606	24	44			

51				PHILIPS	OSRAM 6721	P36d Vertical
						LAMP NO
	R312	6	30/24			

52				PHILIPS 13293	OSRAM	P36d Axial
						LAMP NO
	R331	24	44			

Vehicle Lighting

Standard Bulbs



53

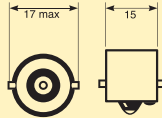
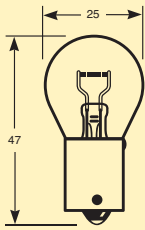

P21W

BA15s (SCC)

LAMP NO	VOLTS	WATTS	ECE NO	DESCRIPTION	COLOUR	PHILIPS	OSRAM	GE / TUNGSRAM
Ⓢ R317	6	21	P21W			6498	7501	1053
R240	12	15				12401		1143
R385	12	18				12445		1059
R343	12	21			●			1057L
R1003	12	15CP						
Ⓢ RW382RR	12	21	P21W	■ Rapid Response		12498VP		1057NH
Ⓢ R382LL	12	21	P21W	■ Long life		12498ECO/12498LL	7506ULT	1057LFD
R243	24	15				13401	7529	1115
Ⓢ R241	24	21	P21W			13498	7511	1060
Ⓢ R290	24	21	P21W	■ Heavy Duty		13498MD	9511	1060HD
R347	24	21			●			
R339	24	24						91362
R345	28	26						
R4598	48	25						

54

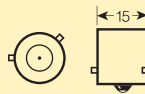
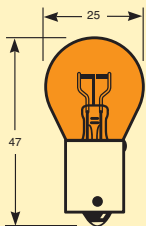

PY21W

BAU15s (OSP)

LAMP NO	VOLTS	WATTS	ECE NO	DESCRIPTION	COLOUR	PHILIPS	OSRAM	GE / TUNGSRAM
Ⓢ R581	12	21	PY21W		●	12496	7507	1056
Ⓢ R581LL	12	21	PY21W	■ Long life	●	12496LL	7507ULT	1056LFD
R586	12	21						
Ⓢ R3581	12	21	PY21W		●	12496SV	7507LDA	
Ⓢ R588	24	21	PY21W		●	13496	7510	1073

55

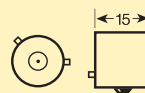
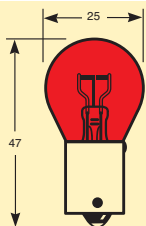

PR21W

BAW15s

LAMP NO	VOLTS	WATTS	ECE NO	DESCRIPTION	COLOUR	PHILIPS	OSRAM	GE / TUNGSRAM
Ⓢ R782	12	21	PR21W		●	12088	7508LDR	
Ⓢ R3782	12	21	PR21W		●		7538LDR	

56

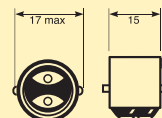
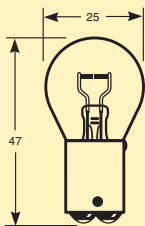

P21W

BA15d (SBC)

LAMP NO	VOLTS	WATTS	ECE NO	DESCRIPTION	COLOUR	PHILIPS	OSRAM	GE / TUNGSRAM
Ⓢ R319	6	21	P21W			6402	6402	
Ⓢ R335	12	21	P21W			12442		1058
R436	24	12						
Ⓢ R346	24	21	P21W			24004		1061
Ⓢ R291	24	21	P21W	■ Heavy Duty				1061HD
R333	24	24						
R344	28	26						

57									BA15d (SBC)
				LAMP NO	VOLTS	WATTS	ECE NO	DESCRIPTION	COLOUR
	R383	6	21/5	-			6503	7540	
	R381	12	21/5	-			12503	7240	1098

58									P21/5W
									BAY15d (OSP)
	LAMP NO	VOLTS	WATTS	ECE NO	DESCRIPTION	COLOUR	PHILIPS	OSRAM	GE / TUNGSRAM
	© R384	6	21/5	P21/5W			6499	7517	1076
	© R380	12	21/5	P21/5W			12499	7528	1077
	© RW380RR	12	21/5	P21/5W	■ Rapid Response		12499VP		1077NH
	© R380LL	12	21/5	P21/5W	■ Long life		12499LL/12499LLECO	7528ULT	1077LFD
	R32/3	12	32/4CP						
	© R294	24	21/5	P21/5W			13499	7537	1078
	R334	24	24/6						
	R4896	48	25/10						

59									PR21/5W
									BAW15d
	LAMP NO	VOLTS	WATTS	ECE NO	DESCRIPTION	COLOUR	PHILIPS	OSRAM	GE / TUNGSRAM
	© R780	12	21/5	PR21/5W		●	12495	7538LDR	
	© R3780	12	21/5	PR21/5W		●		7538LDR	

60									P21/4W
									BAZ15d
	LAMP NO	VOLTS	WATTS	ECE NO	DESCRIPTION	COLOUR	PHILIPS	OSRAM	GE / TUNGSRAM
	© R566	12	21/4	P21/4W			12594	7225	1122
	© R567	24	21/4	P21/4W					

Vehicle Lighting

61

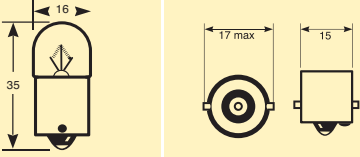



R5W R10W

BA15s (SCC)

LAMP NO	VOLTS	WATTS	ECE NO	DESCRIPTION	COLOUR	PHILIPS	OSRAM	GE / TUNGSRAM
Ⓞ R205	6	5	R5W			6821	5006	2615
Ⓞ R244	6	10	R10W			6814	5001	2639
Ⓞ RW207RR	12	5	R5W	■ Rapid Response			2619NH	2619NH
Ⓞ R207LL	12	5	R5W	■ Long life		12821LL/12821LLECO	5007ULT	2619LFD
Ⓞ R245	12	10	R10W			12814	5008	2641
Ⓞ RW245RR	12	10	R10W	■ Rapid Response				
Ⓞ R245LL	12	10	R10W	■ Long life		12814LLECO	5008ULT	2641LFD
Ⓞ R909	12	21						
Ⓞ R149	24	5	R5W			13821	5627	2627
Ⓞ R248	24	5	R5W	■ Heavy Duty		13821MD		2627HD
Ⓞ R246	24	10	R10W			13814MD	5637TSP	2643
Ⓞ R295	24	10	R10W	■ Heavy Duty		13814MD	5637	2643HD
Ⓞ R874	28	7						
Ⓞ R4187	48	10						

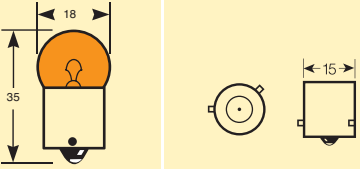
62





RY10W

BAU15s

LAMP NO	VOLTS	WATTS	ECE NO	DESCRIPTION	COLOUR	PHILIPS	OSRAM	GE / TUNGSRAM
Ⓞ R589	12	10	RY10W		●	12093NA	5009	

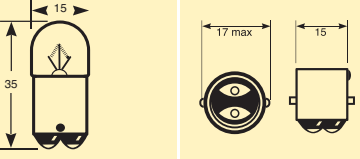
63





R5W

BA15d (SBC)

LAMP NO	VOLTS	WATTS	ECE NO	DESCRIPTION	COLOUR	PHILIPS	OSRAM	GE / TUNGSRAM
Ⓞ R206	6	5	R5W			6822	5406	2614
Ⓞ R209	12	5	R5W			12822	5407	2618
Ⓞ R210	12	10						2640
Ⓞ R150	24	5	R5W			13822	5626	2626
Ⓞ R247	24	5	R5W	■ Heavy Duty				2626HD
Ⓞ R875	28	7						

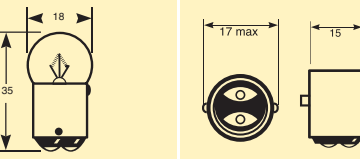
64

BAY15d (OSP)

LAMP NO	VOLTS	WATTS	ECE NO	DESCRIPTION	COLOUR	PHILIPS	OSRAM	GE / TUNGSRAM
Ⓞ R4192	48	10						

65									
								T4W	
								BA9s (MCC)	
LAMP NO	VOLTS	WATTS	ECE NO	DESCRIPTION	COLOUR	PHILIPS	OSRAM	GE / TUNGSRAM	
Ⓞ R293	6	4	T4W			6929	3892	2659	
Ⓞ R233	12	4	T4W			12929	3893	2662	
Ⓞ R233LL	12	4	T4W	■ Long life		12929LL		2662LFD	
Ⓞ R833	12	4	T4W	■ IceBlue	●		3893CB		
R143	24	2.8							
Ⓞ R249	24	4	T4W			13929	3930	2661	
R249G	24	4			●				
Ⓞ R296	24	4	T4W	■ Heavy Duty		13929MD		2661HD	
R1590	48	5							

66									
								BA9s (MCC)	
LAMP NO	VOLTS	WATTS	ECE NO	DESCRIPTION	COLOUR	PHILIPS	OSRAM	GE / TUNGSRAM	
R951	6	5							
R989	12	5					3860		
R992	12	10							
R227	24	5							

67									
								W3W W5W	
								W2.1 x 9.5d	
LAMP NO	VOLTS	WATTS	ECE NO	DESCRIPTION	COLOUR	PHILIPS	OSRAM	GE / TUNGSRAM	
R297	12	2.2				12960	2820	5313	
Ⓞ R504	12	3	W3W			12256	2821	504	
Ⓞ R501	12	5	W5W			12961	2825	501	
R506	12	6				12040	2886X		
Ⓞ R501LL	12	5	W5W	■ Long life		12961ECO/12961LL	2825ULT	930FD	
Ⓞ R501HD	12	5	W5W	■ Heavy Duty		12961			
Ⓞ R801	12	5	W5W	■ IceBlue	●		2825HCBN	91625 BLUE	
Ⓞ R1401	12	5	W5W	■ Xenon4000		12256BV	2825HCBN		
R298	24	2.2				13960	2840		
Ⓞ R505	24	3	W3W			13256	2841	5305	
Ⓞ R507	24	5	W5W			13961	2845	91622	
R507B	24	5			●				

68									
								WY5W	
								W2.1 x 9.5d	
LAMP NO	VOLTS	WATTS	ECE NO	DESCRIPTION	COLOUR	PHILIPS	OSRAM	GE / TUNGSRAM	
Ⓞ R501A	12	5	WY5W		●	12396NA	2827	501A	

Vehicle Lighting

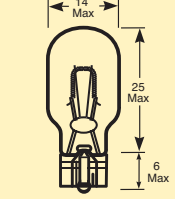
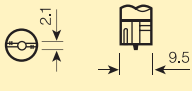
69								
				W2.1 x 9.5d				
LAMP NO	VOLTS	WATTS	ECE NO	DESCRIPTION	COLOUR	PHILIPS	OSRAM	GE / TUNGSRAM
R922	12	10						
R923	24	10						

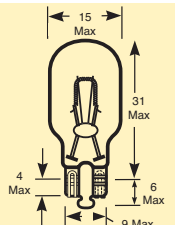
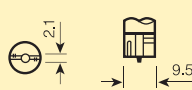
70								
				W16W				
W2.1 x 9.5d								
LAMP NO	VOLTS	WATTS	ECE NO	DESCRIPTION	COLOUR	PHILIPS	OSRAM	GE / TUNGSRAM
© R955	12	16	W16W			12067	921	W16W
R921	12	21CP						

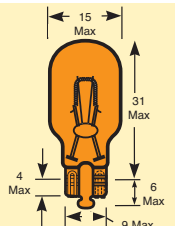
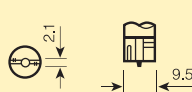
71								
				WY16W				
W2.1 x 9.5d								
LAMP NO	VOLTS	WATTS	ECE NO	DESCRIPTION	COLOUR	PHILIPS	OSRAM	GE / TUNGSRAM
© R958	12	16	WY16W		●		921NA	NY16WNAL
R921A	12	21CP			●			

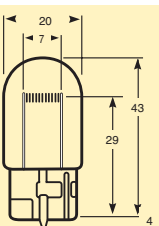
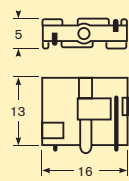
72								
				W21W				
W3 x 16d								
LAMP NO	VOLTS	WATTS	ECE NO	DESCRIPTION	COLOUR	PHILIPS	OSRAM	GE / TUNGSRAM
© R582	12	21	W21W			12065	7505	7440

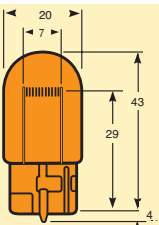
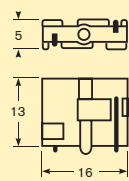
73								
				WY21W				
WX3 x 16d								
LAMP NO	VOLTS	WATTS	ECE NO	DESCRIPTION	COLOUR	PHILIPS	OSRAM	GE / TUNGSRAM
© R585	12	21	WY21W		●	12071	7504	7440NA

74									W21/5W
									W3 x 16q
LAMP NO	VOLTS	WATTS	ECE NO	DESCRIPTION	COLOUR	PHILIPS	OSRAM	GE / TUNGSRAM	
© R580	12	21/5	W21/5W			12066	7515	7443	

75									P27W
									W2.5 x 16d
LAMP NO	VOLTS	WATTS	ECE NO	DESCRIPTION	COLOUR	PHILIPS	OSRAM	GE / TUNGSRAM	
© R182	12	27	P27W				3156		
R184	12	27	-		●				

76									P27/7W
									W2.5 x 16q
LAMP NO	VOLTS	WATTS	ECE NO	DESCRIPTION	COLOUR	PHILIPS	OSRAM	GE / TUNGSRAM	
© R180	12	27/7	P27/7W				3157		



77									PY27/7W
									WX2.5 x 16q
LAMP NO	VOLTS	WATTS	ECE NO	DESCRIPTION	COLOUR	PHILIPS	OSRAM	GE / TUNGSRAM	
© R183	12	27/7	PY27/7W		●		3757AK		

Hiper Vision

78									P13W
									PCY16W
LAMP NO	VOLTS	WATTS	ECE NO	DESCRIPTION	COLOUR	PHILIPS	OSRAM	GE / TUNGSRAM	
© R12277	12	13	P13W			12277			
© R925	12	16	PCY16W		●				

Vehicle Lighting

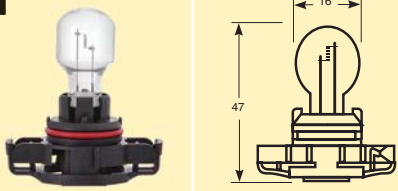
79





**PS19W
PSY19W**

PG20-1 / PG20-2

LAMP NO	VOLTS	WATTS	ECE NO	DESCRIPTION	COLOUR	PHILIPS	OSRAM	GE / TUNGSRAM
Ⓒ R12085	12	19	PS19W			12085	5201	
Ⓒ R12275	12	19	PSY19W		●	12275		

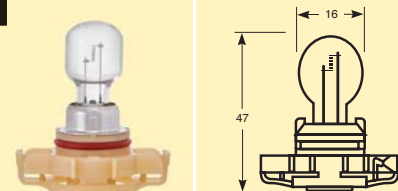
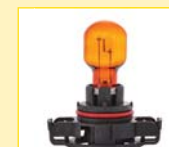
80





**PS24W
PSY24W
PY24W
PSX24W**

PG20-3 / PGU20-4 / PG20-7

LAMP NO	VOLTS	WATTS	ECE NO	DESCRIPTION	COLOUR	PHILIPS	OSRAM	GE / TUNGSRAM
Ⓒ R12086	12	24	PS24W			12086	5202	
Ⓒ R12188	12	24	PSY24W		●	12188NA		
Ⓒ R12190	12	24	PY24W		●	12190NA		
Ⓒ R12274	12	24	PY24W		●	12274SV+		
Ⓒ R12276	12	24	PSX24W		●	12276	2504	

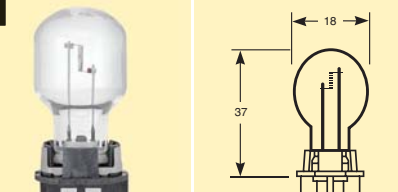
81



**PW24W
PWY24W**

WP3.3x14.5-4

LAMP NO	VOLTS	WATTS	ECE NO	DESCRIPTION	COLOUR	PHILIPS	OSRAM	GE / TUNGSRAM
Ⓒ R12182	12	24	PW24W			12182HTR		
Ⓒ R12174	12	24	PWY24W		●	R12174		

82

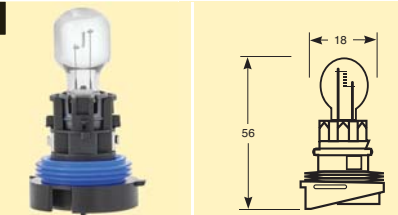

P24W

PU20-3

LAMP NO	VOLTS	WATTS	ECE NO	DESCRIPTION	COLOUR	PHILIPS	OSRAM	GE / TUNGSRAM
Ⓒ R928	12	24	P24W			13625		

83

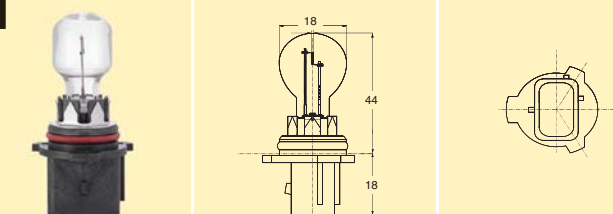

PSX26W

PG18.5d-3

LAMP NO	VOLTS	WATTS	ECE NO	DESCRIPTION	COLOUR	PHILIPS	OSRAM	GE / TUNGSRAM
Ⓒ R12278	12	26	PSX26W			12278		

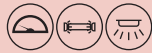
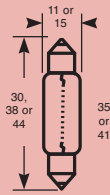
Festoon

84

C5W

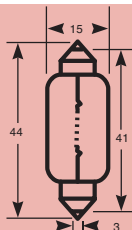
S8.5d

LAMP NO	VOLTS	WATTS	SIZE	ECE NO	DESCRIPTION	COLOUR	PHILIPS	OSRAM	GE / TUNGSRAM
Ⓔ R253	6	5	11x38	C5W			6844	6416	7544
Ⓔ R239	12	5	11x38	C5W			12844	6418	7546
Ⓔ R239LL	12	5	11x38	C5W	■ Long life			6418ULT	7546LFD
R258	12	5	11x42				12864	6413	7575
R254	12	6	11x38					6486X	
R237	12	7	10x40				12144		
R264	12	10	11x44					6411	7576
R269	12	10	11x30				12860	6438	7585
R272	12	10	11x38				12854	6461	91715
Ⓔ R242	24	5	11x38	C5W			13844	6423	7552
R242G	24	5	11x38			●			
R260	24	5	11x42				13864	6424	7579
R653	24	6	11x38				13844		
R274	24	10	11x41				13866	6429	7580

85

C21W

S8.5d

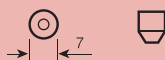
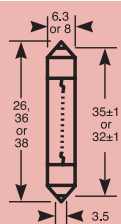
LAMP NO	VOLTS	WATTS	SIZE	ECE NO	DESCRIPTION	COLOUR	PHILIPS	OSRAM	GE / TUNGSRAM
R266	6	15	15x44						
R265	12	10	15x44						
R267	12	15	15x44				12850	6541	7592
R270	12	18	15x44				12807	6475	7593
Ⓔ R273	12	21	15x44	C21W			12803	6476	91761
R276	24	18	15x44				13807	8480	7595
R275	24	21	15x44						

86

S6d / S7d

LAMP NO	VOLTS	WATTS	SIZE	ECE NO	DESCRIPTION	COLOUR	PHILIPS	OSRAM	GE / TUNGSRAM
R256	12	3	8x38				12843		
R263	12	3	8x31					2628	91701
R268	12	3	6x36				12848	6428	
R261	12	5	8x26						
R271	24	3	7x30				13818	6430	91702
R908	24	3	8x36					6421	

Vehicle Lighting

Miniature Halogen



87

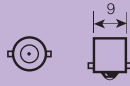
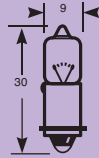

BA9s (MCC)

LAMP NO	VOLTS	WATTS	ECE NO	DESCRIPTION	COLOUR	PHILIPS	OSRAM	GE / TUNGSRAM
R469	12	5				12023	64111	58540
R470	12	10				12024	64113	58560
R433	12	20				12025	64115	56110
R418	12	23			●			
R419	12	23						

88

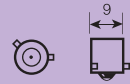
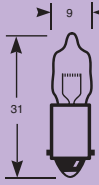

H6W

BAX9s

LAMP NO	VOLTS	WATTS	ECE NO	DESCRIPTION	COLOUR	PHILIPS	OSRAM	GE / TUNGSRAM
© R434	12	6	H6W			12036	64132	52830U

89

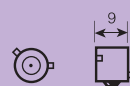
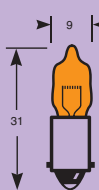

HY6W

BAZ9s

LAMP NO	VOLTS	WATTS	ECE NO	DESCRIPTION	COLOUR	PHILIPS	OSRAM	GE / TUNGSRAM
© R926	12	6	HY6W		●			

90

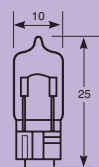

(W5W)

W2.1 x 9.1d

LAMP NO	VOLTS	WATTS	ECE NO	DESCRIPTION	COLOUR	PHILIPS	OSRAM	GE / TUNGSRAM
R516	12	5		■ IceBlue	●		2825HCBN	

91

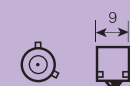
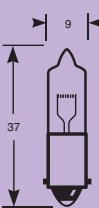

H21W

BAY9s

LAMP NO	VOLTS	WATTS	ECE NO	DESCRIPTION	COLOUR	PHILIPS	OSRAM	GE / TUNGSRAM
© R435	12	21	H21W			12356	64136	
© R535	24	21	H21W			24356	64138	

92									HY21W
									BAW9s
LAMP NO	VOLTS	WATTS	ECE NO	DESCRIPTION	COLOUR	PHILIPS	OSRAM	GE / TUNGSRAM	
© R927	12	21	HY21W		●	12146	64137ULT		

93									BA15s (SCC)
LAMP NO	VOLTS	WATTS	ECE NO	DESCRIPTION	COLOUR	PHILIPS	OSRAM	GE / TUNGSRAM	
R467	12	5						58570	
R468	12	10						58580	
R740	12	20							
R906	12	21							
R796	12	35							
R795	12	50							
R741	24	20							

94									G4
LAMP NO	VOLTS	WATTS	ECE NO	DESCRIPTION	COLOUR	PHILIPS	OSRAM	GE / TUNGSRAM	
R569	12	5							
R570	12	10							
R573	12	20							
R574	24	10							
R571	24	20							

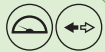
Panel and Indicator

95									T5
									W2.3W
								WY2.3W	
								W2 x 4.6d	
LAMP NO	VOLTS	WATTS	ECE NO	DESCRIPTION	COLOUR	PHILIPS	OSRAM	GE / TUNGSRAM	
R286	12	1.2							
R286A	12	1.2			●	12516	2721	5301	
R286B	12	1.2			●				
R286G	12	1.2			●				
R286R	12	1.2			●				
© R284	12	2.3	W2.3W			12061	2723	91605	
© R284A	12	2.3	WY2.3W		●				
R1030	14	0.9(65mA)							
R508	24	1.2				13516	2741	91602	
R508A	24	1.2			●				
R508B	24	1.2			●				
R508G	24	1.2			●				
R508R	24	1.2			●				

Vehicle Lighting

96

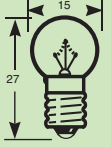
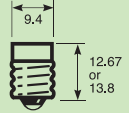
E10/13/14 MES

LAMP NO	VOLTS	WATTS	ECE NO	DESCRIPTION	COLOUR	PHILIPS	OSRAM	GE / TUNGSRAM
R950	6	6						
R862	12	5						2683
R993	24	2.8				13875		

97



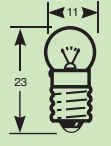
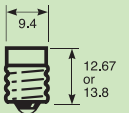

G11

E10/13 MES

LAMP NO	VOLTS	WATTS	ECE NO	DESCRIPTION	COLOUR	PHILIPS	OSRAM	GE / TUNGSRAM
R982	6	1.8						
R990	6	3				6875	3965	
R987	12	2.2				12875	3766	2683
R650	24	2.8				13875	3967	

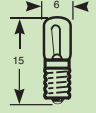
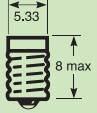
98

E5/8 LES

LAMP NO	VOLTS	WATTS	ECE NO	DESCRIPTION	COLOUR	PHILIPS	OSRAM	GE / TUNGSRAM
R280	12	1.5					12926	
R864/14	14	0.5						
R695	24	2.8						

99

BA9s MCC

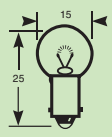
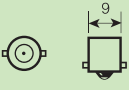
LAMP NO	VOLTS	WATTS	ECE NO	DESCRIPTION	COLOUR	PHILIPS	OSRAM	GE / TUNGSRAM
R651	24	2.8						

100



Midget Groove

LAMP NO	VOLTS	WATTS	ECE NO	DESCRIPTION	COLOUR	PHILIPS	OSRAM	GE / TUNGSRAM
R388	28	1.2 (40mA)						

101										
										BA9s MCC
LAMP NO	VOLTS	WATTS	ECE NO	DESCRIPTION	COLOUR	PHILIPS	OSRAM	GE / TUNGSRAM		
R641	6	3				6910	6910			
R643	12	2.2				12910	3894			
R865	24	2.8				13910	6251			

102										
										BA7s Peanut
LAMP NO	VOLTS	WATTS	ECE NO	DESCRIPTION	COLOUR	PHILIPS	OSRAM	GE / TUNGSRAM		
R282	6	1.2				6829	3798	2960		
R281	12	2				12829	3898	2696		
R283	24	3				13829	3899	2692		

103										
										BA9s MCC (Tub.)
LAMP NO	VOLTS	WATTS	ECE NO	DESCRIPTION	COLOUR	PHILIPS	OSRAM	GE / TUNGSRAM		
R287	6	2					3895			
R288	12	2				12913	3796	2660		
R289	24	2				13913	3797	2663		



Printed Circuit Board Lamps



104										
										B8.4D / BX8.4D
LAMP NO	VOLTS	WATTS	BASE COLOUR	PANEL THICKNESS	PHILIPS	OSRAM	GE / TUNGSRAM			
R509TMGY	12	0.5	Grey BX8.4D	1.5mm						
R509TMOR	12	1.12	Orange BX8.4D	1.5mm	12624	2473MFX6				
R509TMBK	12	1.2	Black BX8.4D	1.5mm	12625	2351MFX6	91641PS			
R509TMBL	12	1.2	Blue B8.4D	2.0mm	12623	2351MF6				
R509TMBE	12	1.5	Beige BX8.4D	1.5mm	12627	2452MFX6	91646PS			
R509TMGR	12	2	Light Green 8.4D	2.0mm	12626	2352MFX6	91645PS			
R508TMGR	24	1.4	Light Green 8.4D							
R508TMRE	24	1.5	Red BX8.4D							

Vehicle Lighting

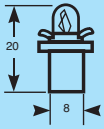

105

B8.5D / BX8.5D

LAMP NO	VOLTS	WATTS	BASE COLOUR	PANEL THICKNESS	PHILIPS	OSRAM	GE / TUNGSRAM
R509TVI	12	0.4	Violet BX8.5D	1.5mm	12640	2322MFX	
R509TOR	12	1	Orange BX8.5D	1.5mm		2321MFX	
R509T	12	1.2	Black B8.5D	2.0mm	12598	2721MF	5301PS
R509TBL	12	1.2	Light Blue BX8.5D	1.5mm	12603	2721MFX	
R509TBE	12	1.5	Beige B8.5D	2.0mm	12637	2752MF	
R509TGR	12	2	Green B8.5D	2.0mm	12600	2722MF	5303PS
R508T	24	1.2	Grey B8.5D		13598	2741MF	5302PS
R508TBR	24	1.2	Brown BX8.5D		24032	2741MFX	

106

B8.7D

LAMP NO	VOLTS	WATTS	BASE COLOUR	PANEL THICKNESS	PHILIPS	OSRAM	GE / TUNGSRAM
R509TWGY	12	1.2	Grey			2721MF8W	
R508TWBR	24	1.2	Brown				



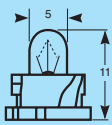
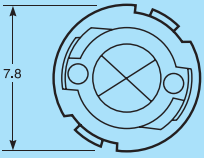
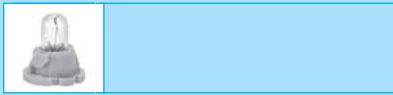

107

F4.8

LAMP NO	VOLTS	WATTS	BASE COLOUR	PANEL THICKNESS	PHILIPS	OSRAM	GE / TUNGSRAM
R509TFBK/12	12	1.2	Black				
R509TFGY	12	1.8	Grey				
R509TFBK/14	14	1.4	Black			2722MF	91695PS14V

108

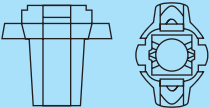
B8.3D

LAMP NO	VOLTS	WATTS	BASE COLOUR	PANEL THICKNESS	PHILIPS	OSRAM	GE / TUNGSRAM
R509TBBK	12	1.2	Black		12597	2721MF8	91671PS
R509TBWH	12	2	White			2722MF8	91665PS
R508TBGY	24	1.2	Grey		13597	2741MF8	

109					BAX EBSR		
LAMP NO	VOLTS	WATTS	BASE COLOUR	PANEL THICKNESS	PHILIPS	OSRAM	GE / TUNGSRAM
R86021001	12	1.2	Green	2.0mm			
R86021002	12	1.8	Blue	2.0mm			91696PS
R6929	24	1.2	Light Green				
R1471	24	1.2 (40mA)	Brown		24506		91693
R1791	24	1.2 (53mA)	Yellow		24029		91693

110					B10d		
LAMP NO	VOLTS	WATTS	BASE COLOUR	PANEL THICKNESS	PHILIPS	OSRAM	GE / TUNGSRAM
R64122	12	3	Brown		12614	64122MF	
R64124	12	5	Black		12615	64122MF	

111					BX2D		
LAMP NO	VOLTS	WATTS	BASE COLOUR	PANEL THICKNESS	PHILIPS	OSRAM	GE / TUNGSRAM
R509TEBK	12	1.2	Black	1.5mm			

112					T-1/4NW		
LAMP NO	VOLTS	WATTS	BASE COLOUR	PANEL THICKNESS	PHILIPS	OSRAM	GE / TUNGSRAM
R509TDBK	12	1.2	Black				

113					T-1.1/2TW		
LAMP NO	VOLTS	WATTS	BASE COLOUR	PANEL THICKNESS	PHILIPS	OSRAM	GE / TUNGSRAM
R509THGY	14	1.2 (90mA)	Grey				

Vehicle Lighting

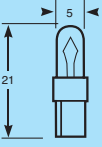
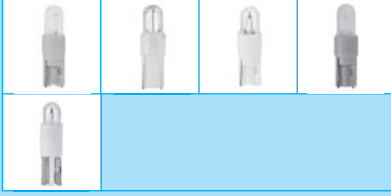
114							KW2 x 4.6D	
LAMP NO	VOLTS	WATTS	BASE COLOUR	PANEL THICKNESS	PHILIPS	OSRAM	GE / TUNGSRAM	
R509TCGY	12	0.5	Grey				91609PS	
R509TCTR	12	1.2	Transparent					
R509TCWH	12	1.2	White					
R509TCGY/1.8	12	1.8	Grey					
R508TCTR	24	1.2	Transparent					
R508TCWH	24	1.2	White					
R508TD	24	1	White					

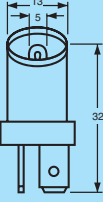
115							B9	
LAMP NO	VOLTS	WATTS	BASE COLOUR	PANEL THICKNESS	PHILIPS	OSRAM	GE / TUNGSRAM	
R513BWH	24	1.5	White					

116							B9	
LAMP NO	VOLTS	WATTS	BASE COLOUR	PANEL THICKNESS	PHILIPS	OSRAM	GE / TUNGSRAM	
R508TUWH	24	2.4	White					

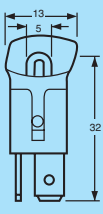
117							B29	
LAMP NO	VOLTS	WATTS	BASE COLOUR	PANEL THICKNESS	PHILIPS	OSRAM	GE / TUNGSRAM	
R508TVWH	24	1.4	White					

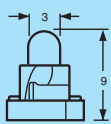
118							T3	
LAMP NO	VOLTS	WATTS	BASE COLOUR	PANEL THICKNESS	PHILIPS	OSRAM	GE / TUNGSRAM	
R509TJBR	14	1.2 (60mA)	Brown					

119								B8.5 5/40
								LAMP NO
	R509TKBK	12	1.2	Black				

120								BG8.5 - 5.5D
								LAMP NO
	R509TLBK	12	1.2	Black				

121								SG8-5.5D
								LAMP NO
	R509TPBK	12	1.2	Black				



122								T3
								LAMP NO
	R509TQWH	14	1.2 (65mA)	White				

123								B11D
								LAMP NO
	R509TSBK	14	1CP	Black				

124								T5
								LAMP NO
	R509TYBK	14	1.4	Black				

Vehicle Lighting

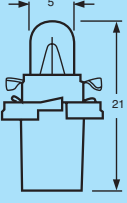
125									KW2.1 x 9.5D
									LAMP NO
	R512WB	12	2	White					

126									EBS-N10
									LAMP NO
	R86021003	24	1.2	Yellow	EBS-N	24606			
	R86024918	24	1.2	Grey	BAX10D				
	R8328	24	1.4	Beige					
	R86028166	24	2.4	Yellow					

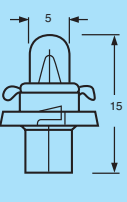
127									EBS-P/PM
									LAMP NO
	R88005996	12.6	1.5	White					

128									PCB
									LAMP NO
	R512PCB	12	2CP	White					

129									B12.3D
									LAMP NO
	R512TR	12	2CP	White					

LED Bulbs

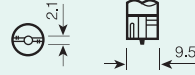
130

(W5W)

W2.1.x9.5d

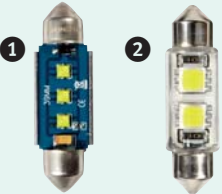
LAMP NO	VOLTS	DESCRIPTION	COLOUR TEMP	LUMENS	PHILIPS	OSRAM	GE
1 RW501DLED	12	Performance LED	7000K	200			
2 RW501CBLED	12	Premium LED	6000K	220			
3 RW5016LED	12	Standard LED	6000K	40			
3 RW50112LED	12	Standard LED	12000K	35			

131

(C5W)

S8.5d 11x38mm

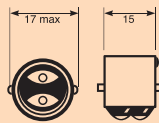
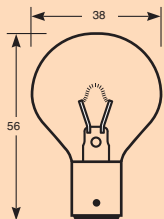
LAMP NO	VOLTS	DESCRIPTION	COLOUR TEMP	LUMENS	PHILIPS	OSRAM	GE
1 RW239CBLED	12	Premium LED	6000K	200			
2 R2396LED	12	Standard LED	6000K	35			
2 R23912LED	12	Standard LED	12000K	35			
1 R2426LED	24	Premium LED	6000K	200			

Bus Bulbs
132

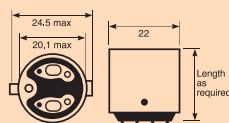
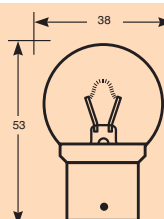
BA15d (SBC)

LAMP NO	VOLTS	WATTS	GLASS	DESCRIPTION	PHILIPS	OSRAM	GE / TUNGSRAM
R805	12	12	Pearl				
R810	12	24	Pearl				
R817	24	12	Pearl				
R822	24	20	Pearl				

133

B22d (BC)

LAMP NO	VOLTS	WATTS	GLASS	DESCRIPTION	PHILIPS	OSRAM	GE / TUNGSRAM
R804	12	12	Pearl				
R816	24	12	Pearl				
R821	24	20	Pearl				
R1184P	24	22	Pearl				

Vehicle Lighting

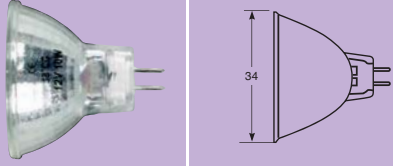
Halogen Interior Bulbs

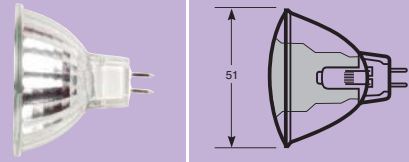
134									
LAMP NO	VOLTS	WATTS	ANGLE	DESCRIPTION	PHILIPS	OSRAM	MR11		
121030XB	12	10	30°						
A122030	12	20	30°						
A123530	12	35	30°						

135									
LAMP NO	VOLTS	WATTS	ANGLE	DESCRIPTION	PHILIPS	OSRAM	MR16/Dichroic		
A241012	24	10	12°						
A242038	24	20	38°						
A243538	24	35	38°						

Fluorescent Tubes

136									
LAMP NO	WATTS	SIZE	DESCRIPTION	DESIGN LIFE	PHILIPS	OSRAM	T5		
A3003	4	6"	White	10000hrs					
A1060	80	4.75ft	Cool White Deluxe	24000hrs					

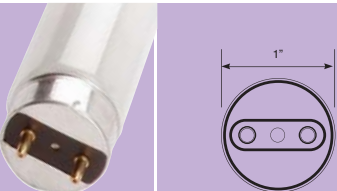
137									
LAMP NO	WATTS	SIZE	DESCRIPTION	DESIGN LIFE	PHILIPS	OSRAM	T8		
A1003-R	15	18"	White	15000hrs					
A1047	15/33	18"	Cool White	20000hrs					
61014B	30	3ft	White	12000hrs					
A1021	36	4ft	Cool White Deluxe	15000hrs					

Inspection/Hand Lamp Bulbs

138

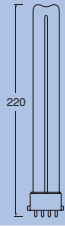

Fluorescent

LAMP NO	VOLTS	WATTS	ECE NO	DESCRIPTION	PHILIPS	OSRAM	GE / TUNGSRAM
RIL200	12/230	11		Compact Fluorescent			

Vehicle Lighting

H1 P14.5s	H2 X511	H3 PK22s	H4 P45t	H4 P43t
ECE Cap	HB3A P20d	HB4 P22d	HB4A P22d	H7 PX22d
H8 PGJ19-1	H8B PGJY19-1	H9 PGJ19-5	H9B PGJY19-5	H10 PY20d
H11 PGJ19-2	H11B PGJY19-2	H12 PZ20d	H13 P26.4t	H15 PGJ23t-1
H16 PGJ19-3	H18 PY26d	H19 PU43t-3	HIR1 PX20d	HIR2 PX22d

D1S PK32d-2

D1R PK32d-3

D2S P32d-2

D2R P32d-3

D3S PK32d-5

D3R PK32d-6

D4S P32d-5

D4R P32d-6

D5S

D8S PK32d-1

S2 BA20D

S3 P26s

PX15D

P15D-3

P15D-25-3

H27W1 PG13

H27W2 PGJ13

P36t

HB1 P29t

HB5 PX29t

MH6R P30t-40

P30/22L

H3r PK22sr

R2 P45t ASY UEC

S1 S2 BA20d (Bosch)

Vehicle Lighting

				
P36d	P36d Axial	P36d Tranverse	P36s Axial	P36s Tranverse
				
P21W BA15s (SCC)	PY21W BAU15s (OSP)	PR21W BAW15s	P21W BA15d (SBC)	BA15d (SBC)
				
P21/5W BAY15d (OSP)	PR21/5W BAW15d	P21/4W BAZ15d	R5W BA15s (SCC)	R10W BA15s (SCC)
				
RY10W BAU15s (SCC)	R5W BA15d (SBC)	BAY15d (OSP)	T4W BA9s (MCC)	BA9s (MCC)
				
W3W W2.1 x 9.5d	W5W W2.1 x 9.5d	W16W W2.1 x 9.5d	W21W W3 x 16d	WY21W W3 x 16d

W21/5W W3 x 16q

P27W WY2.5x 16d

P27/7W W2.5 x 16q

PSX26W

C5W S8.5d

C21W S8.5d

S6d / S7d

BA9s (MCC)

H6W BAX9s (MCC)

H21W BAY9s (MCC)

BA15d (SBC)

BA15s (SCC)

G4

W2.3W W2 x 4.6d

WY2.3W WX2 x 4.6d

E10/13/13 MES

E10/13 MES

E5/8 LESBX8.5D

BA7s Peanut

B8.4D / BX8.4D

B8.5D / BX8.5D

F4.8

B8.3D

BAX EBSR

B10d

Panel thickness
B = 2mm
BX = 1.5mm

Vehicle Lighting

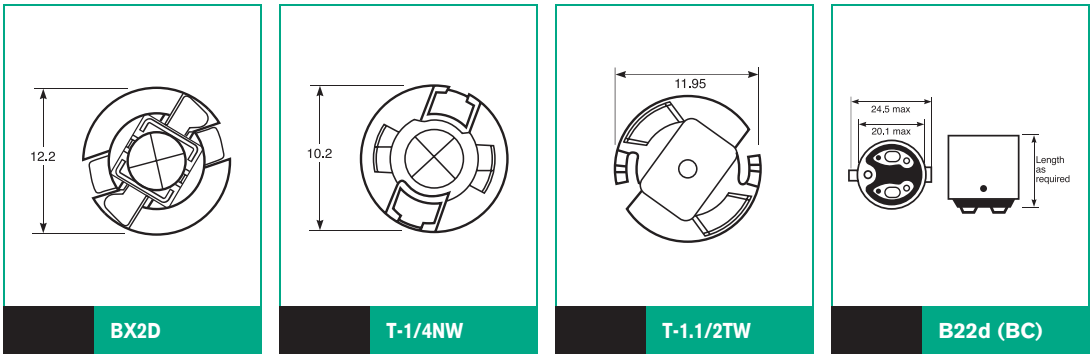

Cap References

- SCC Single Centre Contact
- MCC Miniature Centre Contact
- MES Miniature Edison Screw
- OSP Offset Pin
- SBC Small Bayonet Cap
- ES Edison Screw
- BC Bayonet Cap
- SES Small Edison Screw
- LES Lilliput Edison Screw

ECE	PART NO.	VOLTS	WATTS	CAP	SIZE	DIAGRAM	DESCRIPTION
C5W	R239	12	5	S8.5d	11 x 38mm	84	Festoon
C5W	R239LL	12	5	S8.5d	11 x 38mm	84	Long Life Festoon
C5W	R242	24	5	S8.5d	11 x 38mm	84	Festoon
C5W	R253	6	5	S8.5d	11 x 38mm	84	Festoon
C21W	R273	12	21	S8.5d	15 x 44mm	85	Festoon
D1S	R85402	85	35	PK32d-2	9mm	23	Gas Discharge Headlamp
D2S	R85122	85	35	P32d-2	9mm	24	Gas Discharge Headlamp
D3R	R42306	42	35	PK32d-6	9mm	27	Gas Discharge Headlamp
D3S	R42302	42	35	PK32d-5	9mm	26	Gas Discharge Headlamp
D4R	R42406	42	35	P32d-6	9mm	29	Gas Discharge Headlamp
D4S	R42402	42	35	P32d-5	9mm	28	Gas Discharge Headlamp
H1	RX1048	12	55	P14.5s	10mm	1	Ring Xenon100 Halogen Headlamp
H1	RX1548	12	55	P14.5s	10mm	1	Ring Xenon150 Halogen Headlamp
H1	RX4048	12	55	P14.5S	10mm	1	Ring Xenon4000 Halogen Headlamp
H1	RX5048	12	55	P14.5A	10mm	1	Ring Xenon5000 Halogen Headlamp
H1	RX481	12	100	P14.5S	10mm	1	Ring Rally Sport Halogen Headlamp
H1	RX668	12	80	P14.5S	10mm	1	Ring Sportz Blue Halogen Headlamp
H1	R448	12	55	P14.5s	10mm	1	Halogen Headlamp
H1	R448LL	12	55	P14.5s	10mm	1	Long Life Halogen Headlamp
H1	R465	6	55	P14.5s	10mm	1	Halogen Headlamp
H1	R466	24	70	P14.5s	10mm	1	Halogen Headlamp
H1	R466HD	24	70	P14.5s	10mm	1	Heavy Duty Halogen Headlamp
(H1)	R481	12	100	P14.5s	10mm	1	Ring Rally Sport High Wattage Halogen Headlamp
(H1)	R493	24	100	P14.5s	10mm	1	High Wattage Halogen Headlamp
H1A	R448EQ	12	55	P14.5s	10mm	1	EQ Halogen Headlamp
(H2)	R482	24	70	X511	9mm	2	High Wattage Halogen Accessory Lamp
(H2)	R479	12	55	X511	9mm	2	Halogen Accessory Lamp
(H2)	R494	24	100	X511	9mm	2	Ring Rally Sport High Wattage Halogen Accessory Lamp
H3	R453	12	55	PK22s	11.5mm	3	Halogen Accessory Lamp
H3	R453LL	12	55	PK22s	11.5mm	3	Long Life Halogen Accessory Lamp
H3	R455	6	55	PK22s	11.5mm	3	Halogen Accessory Lamp
H3	R460	24	70	PK22s	11.5mm	3	Halogen Accessory Lamp
H3	R460HD	24	70	PK22s	11.5mm	3	Heavy Duty Halogen Accessory Lamp
(H3)	R441	36	45	PK22s	11.5mm	3	Halogen Accessory Lamp
(H3)	R442	48	45	PK22s	11.5mm	3	Halogen Accessory Lamp
(H3)	R443	80	55	PK22s	11.5mm	3	Halogen Accessory Lamp
(H3)	R444	24	50	PK22s	11.5mm	3	Halogen Accessory Lamp
(H3)	R445	12	10	PK22s	11.5mm	3	Halogen Accessory Lamp
(H3)	R446	12	20	PK22s	11.5mm	3	Halogen Accessory Lamp
(H3)	R449	24	35	PK22s	11.5mm	3	Halogen Accessory Lamp
(H3)	R456	6	15	PK22s	11.5mm	3	Halogen Accessory Lamp
(H3)	R457	6	25	PK22s	11.5mm	3	Halogen Accessory Lamp
(H3)	R462	12	35	PK22s	11.5mm	3	Halogen Accessory Lamp
(H3)	R495	24	100	PK22s	11.5mm	3	Ring Rally Sport High Wattage Halogen Accessory Lamp
H3C	R447	12	55	PK22s	11.5mm	43	Halogen Accessory Lamp
H3C	R960	12	55(85)	P22d/5	12mm	43	Halogen Headlamp Import - 556
H3r	R961	12	55	PK22sr	12mm	41	Halogen Headlamp Import - 453
H4	R012	12	60/55	P45t H4 UEC	17mm	4	Halogen Headlamp
H4	RX1072	12	60/55	P43T	17mm	5	Ring Xenon100 Halogen Headlamp
H4	RX1572	12	60/55	P43T	17mm	5	Ring Xenon150 Halogen Headlamp
H4	RX2072	12	60/55	P43t	17mm	5	Ring Xenon200 Halogen Headlamp
H4	RX4072	12	60/55	P43T	17mm	5	Ring Xenon4000 Halogen Headlamp
H4	RX5072	12	60/55	P43T	17mm	5	Ring Xenon5000 Halogen Headlamp
H4	RX484	12	100/80	P43T	17mm	5	Ring Rally Sport Halogen Headlamp
H4	RX684	12	100/80	P43T	17mm	5	Ring Sportz Blue Halogen Headlamp
H4	R496	24	100/80	P43t	17mm	5	Ring Rally Sport High Wattage Halogen Headlamp
H4	R498	24	130/90	P43t	17mm	5	Ring Rally Sport High Wattage Halogen Headlamp
H4	R905	6	60/55	P43t H4	17mm	5	Halogen Headlamp
H4	R472	12	60/55	P43t	17mm	5	Halogen Headlamp
H4	R472EQ	12	60/55	P43t	17mm	5	EQ Halogen Headlamp
H4	R472HD	12	60/55	P43t	17mm	5	Heavy Duty Halogen Headlamp
H4	R472LL	12	60/55	P43t	17mm	5	Long Life Halogen Headlamp
H4	R475	24	75/70	P43t	17mm	5	Halogen Headlamp
H4	R475HD	24	75/70	P43t	17mm	5	Heavy Duty Halogen Headlamp
(H4)	R024	24	75/70	P45t H4 UEC	17mm	4	Halogen Headlamp
(H4)	R497	24	100/80	P45t	17mm	4	Ring Rally Sport High Wattage Halogen Headlamp
(H4)	R911	12	45/40	P43t	17mm	5	Halogen Headlamp
H6W	R434	12	6	BAX9s	9mm	88	Miniature Halogen
HY6W	R926	12	6	BAZ9s	9mm	89	Miniature Halogen - Amber
H7	RX1077	12	55	PX26D	11.6mm	10	Ring Xenon100 Halogen Headlamp
H7	RX1577	12	55	PX26D	11.6mm	10	Ring Xenon150 Halogen Headlamp
H7	RX2077	12	55	PX26d	11.6mm	10	Ring Xenon200 Halogen Headlamp
H7	RX4077	12	55	PX26D	11.6mm	10	Ring Xenon4000 Halogen Headlamp
H7	RX5077	12	55	PX26D	11.6mm	10	Ring Xenon5000 Halogen Headlamp
H7	RX464**	12	100	PX26D	11.6mm	10	Ring Rally Sport Halogen Headlamp
H7	RX664**	12	80	PX26D	11.6mm	10	Ring Sportz Blue Halogen Headlamp

Vehicle Lighting

ECE	PART NO.	VOLTS	WATTS	CAP	SIZE	DIAGRAM	DESCRIPTION
H7	R474	24	70	PX26d	11.6mm	10	Halogen Headlamp
H7	R474HD	24	70	PX26d	11.6mm	10	Heavy Duty Halogen Headlamp
H7	R477	12	55	PX26d	11.6mm	10	Halogen Headlamp
H7	R477EL	12	55	PX26d	11.6mm	10	Extra Life/Halogen Headlamp
H7	R477EQ	12	55	PX26d	11.6mm	10	EQ Halogen Headlamp
H7	R477LL	12	55	PX26d	11.6mm	10	Long Life Halogen Headlamp
(H7)	R454	24	100	PX26d	11.6mm	10	High Wattage Halogen Headlamp
H8	R708	12	35	PGJ19-1	11.6mm	11	Halogen Headlamp
H8B	R920	12	35	PGJY19-1	15mm	12	Halogen Headlamp
H9	R709	12	65	PGJ19-5	11.6mm	13	Halogen Headlamp
H9B	R919	12	65	PGJY19-5	15mm	14	Halogen Headlamp
H10	R710	12	42	PY20d	16mm	15	Halogen Headlamp
H11	R458HD	24	70	PGJ19-2	11.6mm	16	Heavy Duty Halogen Headlamp
H11	RX1011	12	55	PGJ19-2	11.6mm	16	Ring Xenon100 Halogen Headlamp
H11	RX1511	12	55	PGJ19-2	11.6mm	16	Ring Xenon150 Halogen Headlamp
H11	RX2011	12	55	PGJ19-2	11.6mm	16	Ring Xenon200 Halogen Headlamp
H11	RX5011	12	55	PGJ19-2	11.6mm	16	Ring Xenon5000 Halogen Headlamp
H11	R458	24	70	PGJ19-2	11.6mm	16	Halogen Headlamp
H11	R711	12	55	PGJ19-2	11.6mm	16	Halogen Headlamp
H12	R712	12	53	PZ20d	16mm	17	Halogen Headlamp
H13	R9008	12	60/55	P26.4t	16mm	18	Halogen Headlamp
H15	R715	12	55/15	PGJ26t-1	22mm	19	Halogen Headlamp
H16	R716	12	19	PGJ19-3	11.6mm	21	Halogen Headlamp
H18	R718	12	55	PY26d	15mm	21	Halogen Headlamp
(HB1)	R9004	12	65/45	P29t	14.7mm	39	Halogen Headlamp
HB2	R9003	12	60/55	P43t	17mm	5	Halogen Headlamp
HB3	R9005	12	60	P20d	12mm	6	Halogen Headlamp
HB3	RX1005	12	60	P20D	12mm	6	Ring Xenon100 Halogen Headlamp
HB3A	R9005XS	12	60	P20d	12mm	7	Halogen Headlamp
HB4	RX1006	12	51	P22D	12mm	8	Ring Xenon100 Halogen Headlamp
HB4	R9006	12	51	P22d	12mm	8	Halogen Headlamp
HB4A	R9006XS	12	51	P22d	12mm	9	Halogen Headlamp
(HB5)	R9007	12	65/55	PX29t	33.8mm	39	Halogen Headlamp
HIR2	R9012	12	55	PX22d	20mm	22	Halogen Headlamp
HIR2	R1512	12	55	PX22d	20mm	22	Ring Xenon150 Halogen Headlamp
HIR2	RX1512	12	55	PX22D	20mm	22	Ring Xenon150 Halogen Headlamp
HS1	R459	12	35/35	PX43t	17mm	5	Halogen Headlamp
HS1	R910	6	35/35	PX43t	17mm	5	Halogen Headlamp
HS5	R929	12	35/30	P23t	25mm	30	Motorcycle Headlamp
H21W	R435	12	21	BAY9s	9mm	91	Miniature Halogen Brake/Indicator/Reverse/Rear Fog
H21W	R535	24	21	BAY9s	9mm	91	Miniature Halogen Brake/Indicator/Reverse/Rear Fog
H27W/1	R880	12	27	PG13	9mm	35	Halogen Headlamp
H27W/2	R881	12	27	PGJ13	9mm	36	Halogen Headlamp
HY21W	R927	12	21	BAW9s	9mm	92	Miniature Halogen - Amber
P13W	R12277	12	13	PG18.5d-1	20mm	78	HiPervision Day Time Running
P21/4W	R566	12	21/4	BAZ15d	25mm	60	Fog/Tail
P21/4W	R567	24	21/4	BAZ15d	25mm	60	Fog/Tail
P21/5W	R294	24	21/5	BAY15d (OSP)	25mm	58	Brake/Tail
P21/5W	R380	12	21/5	BAY15d (OSP)	25mm	58	Brake/Tail
P21/5W	RW380RR	12	21/5	BAY15d (OSP)	25mm	58	Rapid Response Brake/Indicator/Reverse/Rear Fog
P21/5W	R380LL	12	21/5	BAY15d (OSP)	25mm	58	Long Life Brake/Tail
P21/5W	R384	6	21/5	BAY15d (OSP)	25mm	58	Brake/Tail
P21W	R241	24	21	BA15s (SCC)	25mm	53	Brake/Indicator/Reverse/Rear Fog
P21W	R290	24	21	BA15s (SCC)	25mm	53	Heavy Duty Brake/Indicator/Reverse/Rear Fog
P21W	R291	24	21	BA15d (SBC)	25mm	56	Heavy Duty Brake/Indicator/Reverse/Rear Fog
P21W	R317	6	21	BA15s (SCC)	25mm	53	Brake/Indicator/Reverse/Rear Fog
P21W	R319	6	21	BA15d (SBC)	25mm	56	Brake/Indicator/Reverse/Rear Fog
P21W	R335	12	21	BA15d (SBC)	25mm	56	Brake/Indicator/Reverse/Rear Fog
P21W	R346	24	21	BA15d (SBC)	25mm	56	Brake/Indicator/Reverse/Rear Fog
P21W	RW382RR	12	21	BA15s (SCC)	25mm	53	Rapid Response Brake/Tail
P21W	R382LL	12	21	BA15s (SCC)	25mm	53	Long Life Brake/Indicator/Reverse/Rear Fog
P24W	R928	12	24	PU20-3	18mm	82	HiPervision Brake/Indicator/Reverse/Rear Fog
P27/7W	R180	12	27/7	W2.5 x 16q	25.5mm	76	Brake & Tail
P27W	R182	12	27	W2.5 x 16d	25.5mm	75	Brake/Indicator/Reverse/Rear Fog
PC16WY	R925	12	16	PU20d-2	20mm	78	HiPervision Indicator - Amber
PR21/5W	R3780	12	21/5	BAW15d	25mm	59	Brake/Tail - Silver Red
PR21/5W	R780	12	21/5	BAW15d	25mm	59	Brake & Tail - Red
PR21W	R3782	12	21	BAW15s	25mm	55	Brake-Silver Red
PR21W	R782	12	21	BAW15s	25mm	55	Brake - Red
PS19W	R12085	12	19	PG20-1	16mm	79	HiPervision Brake/Indicator/Reverse/Rear Fog
PS24W	R12086	12	24	PG20-3	16mm	80	HiPervision Brake/Indicator/Reverse/Rear Fog
PSX24W	R12276	12	24	PG20-7	16mm	80	HiPervision Brake/Indicator/Reverse/Rear Fog
PSX26W	R12278	12	26	PG18.5d-3	18mm	83	HiPervision Brake/Indicator/Reverse/Rear Fog
PSY19W	R12275	12	19	PG20-2	16mm	79	HiPervision Indicator - Amber
PSY24W	R12188	12	24	PG20-4	16mm	80	HiPervision Indicator - Amber
PW24W	R12182	12	24	WP3.3x14.5-3		81	HiPervision Brake/Indicator/Reverse/Rear Fog

ECE	PART NO.	VOLTS	WATTS	CAP	SIZE	DIAGRAM	DESCRIPTION
PY21W	R3581	12	21	BAU15s (OSP)	25mm	54	Indicator - Silver Amber
PY21W	R581	12	21	BAU15s (OSP)	25mm	54	Indicator - Amber
PY21W	R581LL	12	21	BAU15s (OSP)	25mm	54	Long Life Indicator - Amber
PY21W	R588	24	21	BAU15s (OSP)	25mm	54	Indicator - Amber
PY24W	R12190	12	24	PGU20-4	16mm	80	HiPervision Indicator - Amber
PY24W	R12274	12	24	PGU20-4	16mm	80	HiPervision Indicator - Silver Amber
PY27/7W	R183	12	27/7	WX2.5 x 16q	25.5mm	77	HiPervision Indicator - Amber
R2	R410	12	45/40	P45t	40mm	44	Headlamp
R2	R423	6	45/40	P45t	40mm	44	Headlamp
R2	R429	24	55/50	P45t	40mm	44	Headlamp
R2	R904	12	45/40	P45t	17mm	4	Halogen Headlamp
R5W	R149	24	5	BA15s (SCC)	16mm	61	Side & Tail
R5W	R150	24	5	BA15d (SBC)	18mm	63	Side & Tail
R5W	R205	6	5	BA15s (SCC)	16mm	61	Side & Tail
R5W	R206	6	5	BA15d (SBC)	18mm	63	Side & Tail
R5W	RW207RR	12	5	BA15s (SCC)	16mm	61	Rapid Response Side & Tail
R5W	R207LL	12	5	BA15s (SCC)	16mm	61	Long Life Side & Tail
R5W	R209	12	5	BA15d (SBC)	16mm	63	Side & Tail
R5W	R247	24	5	BA15d (SBC)	16mm	63	Heavy Duty Side & Tail
R5W	R248	24	5	BA15s (SCC)	16mm	61	Heavy Duty Side & Tail
R10W	R244	6	10	BA15s (SCC)	16mm	61	Side & Tail
R10W	R245	12	10	BA15s (SCC)	16mm	61	Side & Tail
R10W	R245LL	12	10	BA15s (SCC)	16mm	61	Long Life Side & Tail
R10W	RW245RR	12	10	BA15s (SCC)	16mm	61	Rapid Response Side & Tail
R10W	R246	24	10	BA15s (SCC)	16mm	61	Side & Tail
R10W	R295	24	10	BA15s (SCC)	16mm	61	Heavy Duty Side & Tail
RY10W	R589	12	10	BA15s (SCC)	18mm	62	Indicator - Amber
S1	R392	6	25/25	BA20d Bosch	35mm	47	Headlamp
S1	R394	12	25/25	BA20d Bosch	35mm	47	Headlamp
S2	R393	6	35/35	BA20d Bosch	35mm	47	Headlamp
S2	R395	12	35/35	BA20d Bosch	35mm	47	Headlamp
S2	R417	12	35/35	BA20d Bosch	14mm	34	Halogen Headlamp
S3	R609	6	15	P26s	25mm	31	Headlamp
S3	R610	12	15	P26s	25mm	31	Headlamp
T4W	R833	12	4	BA9s (MCC)	Tub.9mm	65	Ring IceBlue Side & Tail
T4W	R233	12	4	BA9s (MCC)	9mm	65	Side & Tail
T4W	R233LL	12	4	BA9s (MCC)	9mm	65	Long Life Side & Tail
T4W	R249	24	4	BA9s (MCC)	9mm	65	Side & Tail
T4W	R293	6	4	BA9s (MCC)	9mm	65	Side & Tail
T4W	R296	24	4	BA9s (MCC)	9mm	65	Heavy Duty Side & Tail
W16W	R955	12	16	W2.1 x 9.5d	16mm	70	Brake/Indicator/Reverse/Rear Fog
W2.3W	R284	12	2.3	W2 x 4.6d	5mm	95	Panel
W21/5W	R580	12	21/5	W3 x 16q	20.5mm	74	Brake/Tail
W21W	R582	12	21	W3 x 16d	20.5mm	72	Brake/Indicator/Reverse/Rear Fog
W3W	R504	12	3	W2.1 x 9.5d	10mm	67	Side & Tail/Panel/Interior
W3W	R505	24	3	W2.1 x 9.5d	10mm	67	Side & Tail/Panel/Interior
W5W	R1401	12	5	W2.1 x 9.5d	10mm	67	Ring Xenon4000 Side & Tail
W5W	R501HD	12	5	W2.1 x 9.5d	10mm	67	Heavy Duty Side & Tail
W5W	R501	12	5	W2.1 x 9.5d	10mm	67	Side & Tail/Panel/Interior
W5W	R501LL	12	5	W2.1 x 9.5d	10mm	67	Long Life Side & Tail
W5W	R507	24	5	W2.1 x 9.5d	10mm	67	Side & Tail/Panel/Interior
W5W	R801	12	5	W2.1 x 9.5d	10mm	67	Ring IceBlue Side & Tail/ Interior
(W5W)	R516	12	5	W2.1 x 9.5d	10mm	90	Miniature Halogen - Blue
WY16W	R958	12	16	W2.1 x 9.5d	16mm	71	Indicator - Amber
WY2.3W	R284A	12	2.3	W2 x 4.6d	5mm	95	Indicator - Amber
WY21W	R585	12	21	W3 x 16d	20.5mm	73	Indicator - Amber
WY5W	R501A	12	5	W2.1 x 9.5d	10mm	67	Indicator - Amber

Vehicle Lighting

PART NO.	VOLTS	WATTS	ECE	CAP	SIZE	DIAGRAM	DESCRIPTION
R002	12	36		BA15s SCC	38mm	46	Headlamp
R005	12	36		BA15d SBC	38mm	45	Headlamp
R012	12	60/55	H4	P45t H4 UEC	17mm	4	Halogen Headlamp
R024	24	75/70	(H4)	P45t H4 UEC	17mm	4	Halogen Headlamp
R1003	12	15CP		BA15s (SCC)	25mm	53	Caravan & Interior
R1030	14	0.9 (65mA)		W2 x 4.6d	5mm	95	Panel
R1184P	24	22		B22d LBC	38mm	133	Bus Interior- Pearl
R12085	12	19	PS19W	PG20-1	16mm	79	HiPervision Brake/Indicator/Reverse/Rear Fog
R12086	12	24	PS24W	PG20-3	16mm	80	HiPervision Brake/Indicator/Reverse/Rear Fog
R12182	12	24	PW24W	WP3.3x14.5-3		81	HiPervision Brake/Indicator/Reverse/Rear Fog
R12188	12	24	PSY24W	PG20-4	16mm	80	HiPervision Indicator - Amber
R12190	12	24	PY24W	PGU20-4	16mm	80	HiPervision Indicator - Amber
R12274	12	24	PY24W	PGU20-4	16mm	80	HiPervision Indicator - Silver Amber
R12275	12	19	PSY19W	PG20-2	16mm	79	HiPervision Indicator - Amber
R12276	12	24	PSX24W	PG20-7	16mm	80	HiPervision Brake/Indicator/Reverse/Rear Fog
R12277	12	13	P13W	PG18.5d-1	20mm	78	HiPervision Day Time Running
R12278	12	26	PSX26W	PG18.5d-3	18mm	83	HiPervision Brake/Indicator/Reverse/Rear Fog
R1401	12	5	W5W	W2.1 x 9.5d	10mm	67	Ring Xenon4000 Side & Tail
R143	24	2.8		BA9s (MCC)		65	Panel/Interior
R1471	24	1.2 (40mA)		BAX EBSR	5mm	109	Panel - Brown Base
R149	24	5	R5W	BA15s (SCC)	16mm	61	Side & Tail
R150	24	5	R5W	BA15d (SBC)	18mm	63	Side & Tail
R1512	12	55	HIR2	PX22D	20mm	22	Ring Xenon150 Halogen Headlamp
R1590	48	5		BA9s (MCC)	Tub.9mm	65	Side & Tail
R1791	24	1.2 (53mA)		BAX EBSR	5mm	109	Panel - Yellow Base
R1791LED	24	1.2		BAX EBSR	5mm	134	Panel - Yellow Base
R180	12	27/7	P27/7W	W2.5 x 16q	25.5mm	76	Brake & Tail
R182	12	27	P27W	W2.5 x 16d	25.5mm	75	Brake/Indicator/Reverse/Rear Fog
R183	12	27/7	PY27/7W	WX2.5 x 16q	25.5mm	77	HiPervision Indicator - Amber
R184	12	27		W2.5x16d	25.5mm	75	Indicator - Amber
R185	12	48		P36s	28mm	48	Headlamp
R205	6	5	R5W	BA15s (SCC)	16mm	61	Side & Tail
R206	6	5	R5W	BA15d (SBC)	18mm	63	Side & Tail
R207LL	12	5	R5W	BA15s (SCC)	16mm	61	Long Life Side & Tail
R209	12	5	R5W	BA15d (SBC)	16mm	63	Side & Tail
R210	12	10		BA15d (SBC)	16mm	63	Side & Tail
R227	24	5		BA9s (MCC)	15mm	66	Side & Tail
R233	12	4	T4W	BA9s (MCC)	9mm	65	Side & Tail
R233LL	12	4	T4W	BA9s (MCC)	9mm	65	Long Life Side & Tail
R237	12	7		S8.5d	10 x 40mm	84	Festoon
R239	12	5	C5W	S8.5d	11 x 38mm	84	Festoon
R239LL	12	5	C5W	S8.5d	11 x 38mm	84	Long Life Festoon
R240	12	15		BA15s (SCC)	25mm	53	Side & Tail
R2401LED	24	20mA		Bi-Pin	3mm	133	Panel - LED Black Base
R241	24	21	P21W	BA15s (SCC)	25mm	53	Brake/Indicator/Reverse/Rear Fog
R242	24	5	C5W	S8.5d	11 x 38mm	84	Festoon
R242G	24	5		S8.5d	11 x 38mm	84	Festoon - Green
R243	24	15		BA15s (SCC)	25mm	53	Side & Tail
R244	6	10	R10W	BA15s (SCC)	16mm	61	Side & Tail
R245	12	10	R10W	BA15s (SCC)	16mm	61	Side & Tail
R245LL	12	10	R10W	BA15s (SCC)	16mm	61	Long Life Side & Tail
R246	24	10	R10W	BA15s (SCC)	16mm	61	Side & Tail
R247	24	5	R5W	BA15d (SBC)	16mm	63	Heavy Duty Side & Tail
R248	24	5	R5W	BA15s (SCC)	16mm	61	Heavy Duty Side & Tail
R249	24	4	T4W	BA9s (MCC)	9mm	65	Side & Tail
R249G	24	4		BA9s (MCC)	9mm	65	Interior - Green
R253	6	5	C5W	S8.5d	11 x 38mm	84	Festoon
R254	12	6		S8.5d	11 x 38mm	84	Festoon
R256	12	3		S7d	8 x 38mm	86	Festoon
R258	12	5		S8.5d	11 x 42mm	84	Festoon
R260	24	5		S8.5d	11 x 42mm	84	Festoon
R261	12	5		S7d	8 x 26mm	86	Festoon
R263	12	3		S7d	8 x 31mm	86	Festoon
R264	12	10		S8.5d	11 x 44mm	84	Festoon



PART NO.	VOLTS	WATTS	ECE	CAP	SIZE	DIAGRAM	DESCRIPTION
R265	12	10		S8.5d	15 x 44mm	85	Festoon
R266	6	15		S8.5d	15 x 44mm	85	Festoon
R267	12	15		S8.5d	15 x 44mm	85	Festoon
R268	12	3		S6d	6 x 36mm	86	Festoon
R269	12	10		S8.5d	11 x 30mm	84	Festoon
R270	12	18		S8.5d	15 x 44mm	85	Festoon
R271	24	3		S6d	7 x 30mm	86	Festoon
R272	12	10		S8.5d	11 x 38mm	84	Festoon
R273	12	21	C21W	S8.5d	15 x 44mm	85	Festoon
R274	24	10		S8.5d	11 x 41mm	84	Festoon
R275	24	21		S8.5d	15 x 44mm	85	Festoon
R276	24	18		S8.5d	15 x 44mm	85	Festoon
R280	12	1.5		E5/8	7mm	98	Panel
R281	12	2		BA7s	7mm	102	Panel
R282	6	1.2		BA7s	7mm	102	Panel
R283	24	3		BA7s	7mm	102	Panel
R284	12	2.3	W2.3W	W2 x 4.6d	5mm	95	Panel
R284A	12	2.3	WY2.3W	W2 x 4.6d	5mm	95	Indicator - Amber
R286	12	1.2		W2 x 4.6d	5mm	95	Panel
R286A	12	1.2		W2 x 4.6d	5mm	95	Panel - Amber
R286B	12	1.2		W2 x 4.6d	5mm	95	Panel - Blue
R286G	12	1.2		W2 x 4.6d	5mm	95	Panel - Green
R286R	12	1.2		W2 x 4.6d	5mm	95	Panel - Red
R287	6	2		BA9s MCC	9mm	103	Panel
R288	12	2		BA9s MCC	9mm	103	Panel
R289	24	2		BA9s MCC	9mm	103	Panel
R290	24	21	P21W	BA15s (SCC)	25mm	53	Heavy Duty Brake/Indicator/Reverse/Rear Fog
R291	24	21	P21W	BA15d (SBC)	25mm	56	Heavy Duty Brake/Indicator/Reverse/Rear Fog
R293	6	4	T4W	BA9s (MCC)	9mm	65	Side & Tail
R294	24	21/5	P21/5W	BAY15d (OSP)	25mm	58	Brake/Tail
R295	24	10	R10W	BA15s (SCC)	16mm	61	Heavy Duty Side & Tail
R296	24	4	T4W	BA9s (MCC)	9mm	65	Heavy Duty Side & Tail
R297	12	2.2		W2.1 x 9.5d	10mm	67	Panel
R298	24	2.2		W2.1 x 9.5d	10mm	67	Panel
R312	6	30/24		P36d	28mm	51	Headlamp
R317	6	21	P21W	BA15s (SCC)	25mm	53	Brake/Indicator/Reverse/Rear Fog
R319	6	21	P21W	BA15d (SBC)	25mm	56	Brake/Indicator/Reverse/Rear Fog
R32/3	12	32/4 CP		BAY15d (OSP)	25mm	58	Daylight Running
R330	24	44		P36d	28mm	49	Headlamp
R331	24	44		P36d	28mm	52	Headlamp
R333	24	24		BA15d (SBC)	25mm	56	Brake/Indicator/Reverse/Rear Fog
R334	24	24/6		BAY15d (OSP)	25mm	58	Brake/Tail
R335	12	21	P21W	BA15d (SBC)	25mm	56	Brake/Indicator/Reverse/Rear Fog
R339	24	24		BA15s (SCC)	25mm	53	Brake/Indicator/Reverse/Rear Fog
R343	12	21		BA15s (SCC)	25mm	53	Indicator - Amber
R344	28	26		BA15d (SBC)	25mm	56	Brake/Indicator/Reverse/Rear Fog
R345	28	26		BA15s (SCC)	25mm	53	Brake/Indicator/Reverse/Rear Fog
R346	24	21	P21W	BA15d (SBC)	25mm	56	Brake/Indicator/Reverse/Rear Fog
R347	24	21		BA15s (SCC)	25mm	53	Indicator - Amber
R3581	12	21	PY21W	BAU15s (OSP)	25mm	54	Indicator - Silver Amber
R3603	12	25/25		PX15D	19mm	32	Motorcycle Headlamp
R3625	6	25/25		PX15D	19mm	32	Motorcycle Headlamp
R3780	12	21/5	PR21/5W	BAW15d	25mm	59	Brake/Tail - Silver Red
R3782	12	21	PR21W	BAW15s	25mm	55	Brake-Silver Red
R380	12	21/5	P21/5W	BAY15d (OSP)	25mm	58	Brake/Tail
R380LL	12	21/5	P21/5W	BAY15d (OSP)	25mm	58	Long Life Brake/Tail
R381	12	21/5		BA15d (SBC)	25mm	57	Brake/Tail
R382LL	12	21	P21W	BA15s (SCC)	25mm	53	Long Life Brake/Indicator/Reverse/Rear Fog
R383	6	21/5		BA15d (SBC)	25mm	57	Brake/Tail
R384	6	21/5	P21/5W	BAY15d (OSP)	25mm	58	Brake/Tail
R385	12	18		BA15s (SCC)	25mm	53	Side & Tail
R388	28	1.2 (40mA)		Midget groove	6mm	100	Panel
R392	6	25/25	S1	BA20d Bosch	35mm	47	Headlamp
R393	6	35/35	S2	BA20d Bosch	35mm	47	Headlamp

Vehicle Lighting

PART NO.	VOLTS	WATTS	ECE	CAP	SIZE	DIAGRAM	DESCRIPTION
R394	12	25/25	S1	BA20d Bosch	35mm	47	Headlamp
R395	12	35/35	S2	BA20d Bosch	35mm	47	Headlamp
R396	12	45/40		BA20d Bosch	35mm	47	Headlamp
R398	24	45/40		BA20d Bosch	35mm	47	Headlamp
R410	12	45/40	R2	P45t	40mm	44	Headlamp
R416	12	60/60		P45t ASY UEC	40mm	44	Headlamp
R417	12	35/35	S2	BA20d Bosch	14mm	34	Halogen Headlamp
R418	12	23		BA9s (MCC)	9mm	87	Miniature Halogen - Amber
R4187	48	10		BA15s (SCC)	16mm	61	Side & Tail
R419	12	23		BA9s (MCC)	9mm	87	Miniature Halogen Brake/Indicator/Reverse/Rear Fog
R4192	48	10		BAY15d (OSP)	18mm	64	Side & Tail
R423	6	45/40	R2	P45t	40mm	44	Headlamp
R42302	42	35	D3S	PK32d-5	9mm	26	Gas Discharge Headlamp
R42306	42	35	D3R	PK32d-6	9mm	27	Gas Discharge Headlamp
R42402	42	35	D4S	P32d-5	9mm	28	Gas Discharge Headlamp
R42406	42	35	D4R	P32d-6	9mm	29	Gas Discharge Headlamp
R429	24	55/50	R2	P45t	40mm	44	Headlamp
R433	12	20		BA9s (MCC)	9mm	87	Miniature Halogen Brake/Indicator/Reverse/Rear Fog
R434	12	6	H6W	BAX9s	9mm	88	Miniature Halogen
R435	12	21	H21W	BAY9s	9mm	91	Miniature Halogen Brake/Indicator/Reverse/Rear Fog
R436	24	12		BA15d (SBC)	25mm	56	Bus Interior
R441	36	45	(H3)	PK22s	11.5mm	3	Halogen Accessory Lamp
R442	48	45	(H3)	PK22s	11.5mm	3	Halogen Accessory Lamp
R443	80	55	(H3)	PK22s	11.5mm	3	Halogen Accessory Lamp
R444	24	50	(H3)	PK22s	11.5mm	3	Halogen Accessory Lamp
R4048	12	55	H1	P14.5s	10mm	1	Ring Xenon4000 Halogen Headlamp
R445	12	10	(H3)	PK22s	11.5mm	3	Halogen Accessory Lamp
R446	12	20	PK22s (H3)	(H3)	11.5mm	3	Halogen Accessory Lamp
R447	12	55	H3C	PK22s	11.5mm	43	Halogen Accessory Lamp
R448	12	55	H1	P14.5s	10mm	1	Halogen Headlamp
R448EQ	12	55	H1A	P14.5s	10mm	1	EQ Halogen Headlamp
R448LL	12	55	H1	P14.5s	10mm	1	Long Life Halogen Headlamp
R449	24	35	(H3)	PK22s	11.5mm	3	Halogen Accessory Lamp
R453	12	55	H3	PK22s	11.5mm	3	Halogen Accessory Lamp
R453LL	12	55	H3	PK22s	11.5mm	3	Long Life Halogen Accessory Lamp
R454	24	100	(H7)	PX26d	11.6mm	10	High Wattage Halogen Headlamp
R455	6	55	H3	PK22s	11.5mm	3	Halogen Accessory Lamp
R456	6	15	(H3)	PK22s	11.5mm	3	Halogen Accessory Lamp
R457	6	25	(H3)	PK22s	11.5mm	3	Halogen Accessory Lamp
R458	24	70	H11	PGJ19-2	11.6mm	16	Halogen Headlamp
R458HD	24	70	H11	PGJ19-2	11.6mm	16	Heavy Duty Halogen Headlamp
R459	12	35/35	HS1	PX43t	17mm	5	Halogen Headlamp
R4598	48	25		BA15s (SCC)	25mm	53	Brake/Indicator/Reverse/Rear Fog
R460	24	70	H3	PK22s	11.5mm	3	Halogen Accessory Lamp
R460HD	24	70	H3	PK22s	11.5mm	3	Heavy Duty Halogen Accessory Lamp
R462	12	35	(H3)	PK22s	11.5mm	3	Halogen Accessory Lamp
R465	6	55	H1	P14.5s	10mm	1	Halogen Headlamp
R466	24	70	H1	P14.5s	10mm	1	Halogen Headlamp
R466HD	24	70	H1	P14.5s	10mm	1	Heavy Duty Halogen Headlamp
R467	12	5		BA15s (SCC)	9mm	93	Miniature Halogen Caravan & Interior
R468	12	10		BA15s (SCC)	9mm	93	Miniature Halogen Caravan & Interior
R469	12	5		BA9s (MCC)	9mm	87	Miniature Halogen Caravan & Interior
R470	12	10		BA9s (MCC)	9mm	87	Miniature Halogen Caravan & Interior
R472	12	60/55	H4	P43t	17mm	5	Halogen Headlamp
R472EQ	12	60/55	H4	P43t	17mm	5	EQ Halogen Headlamp
R472HD	12	60/55	H4	P43t	17mm	5	Heavy Duty Halogen Headlamp
R472LL	12	60/55	H4	P43t	17mm	5	Long Life Halogen Headlamp
R474	24	70	H7	PX26d	11.6mm	10	Halogen Headlamp
R474HD	24	70	H7	PX26d	11.6mm	10	Heavy Duty Halogen Headlamp
R475	24	75/70	H4	P43t	17mm	5	Halogen Headlamp
R475HD	24	75/70	H4	P43t	17mm	5	Heavy Duty Halogen Headlamp
R477	12	55	H7	PX26d	11.6mm	10	Halogen Headlamp
R477EL	12	55	H7	PX26d	11.6mm	10	Extra Life Halogen Headlamp
R477EQ	12	55	H7	PX26d	11.6mm	10	EQ Halogen Headlamp



PART NO.	VOLTS	WATTS	ECE	CAP	SIZE	DIAGRAM	DESCRIPTION
R477LL	12	55	H7	PX26d	11.6mm	10	Long Life Halogen Headlamp
R479	12	55	(H2)	X511	9mm	2	Halogen Accessory Lamp
R481	12	100	(H1)	P14.5s	10mm	1	Ring Rally Sport High Wattage Halogen Headlamp
R482	24	70	(H2)	X511	9mm	2	High Wattage Halogen Accessory Lamp
R4896	48	25/10		BAY15d (OSP)	25mm	58	Brake & Tail
R493	24	100	(H1)	P14.5s	10mm	1	High Wattage Halogen Headlamp
R494	24	100	(H2)	X511	9mm	2	Ring Rally Sport High Wattage Halogen Accessory Lamp
R495	24	100	(H3)	PK22s	11.5mm	3	Ring Rally Sport High Wattage Halogen Accessory Lamp
R496	24	100/80	H4	P43t	17mm	5	Ring Rally Sport High Wattage Halogen Headlamp
R497	24	100/80	H4	P45t	17mm	4	Ring Rally Sport High Wattage Halogen Headlamp
R498	24	130/90	H4	P43t	17mm	5	Ring Rally Sport High Wattage Halogen Headlamp
R501	12	5	W5W	W2.1 x 9.5d	10mm	67	Side & Tail/Panel/Interior
R501A	12	5	WY5W	W2.1 x 9.5d	10mm	67	Indicator - Amber
R501HD	12	5	W5W	W2.1 x 9.5d	10mm	67	Heavy Duty Side & Tail
R501LL	12	5	W5W	W2.1 x 9.5d	10mm	67	Long Life Side & Tail
R504	12	3	W3W	W2.1 x 9.5d	10mm	67	Side & Tail/Panel/Interior
R505	24	3	W3W	W2.1 x 9.5d	10mm	67	Side & Tail/Panel/Interior
R506	12	6		W2.1 x 9.5d	10mm	67	Side & Tail / Interior
R507	24	5	W5W	W2.1 x 9.5d	10mm	67	Side & Tail/Panel/Interior
R507B	24	5		W2.1 x 9.5d	10mm	67	Panel/Interior - Blue
R508	24	1.2		W2 x 4.6d	5mm	95	Panel
R508A	24	1.2		W2 x 4.6d	5mm	95	Panel - Amber Base
R508B	24	1.2		W2 x 4.6d	5mm	95	Panel - Blue Base
R508G	24	1.2		W2 x 4.6d	5mm	95	Panel - Green Base
R508R	24	1.2		W2 x 4.6d	5mm	95	Panel - Red Base
R508T	24	1.2		B8.5D	5mm	105	Panel - Grey Base
R508TBGY	24	1.2		B8.3D	5mm	108	Panel - Grey Base
R508TBR	24	1.2		BX8.5D	5mm	105	Panel - Brown Base
R508TCTR	24	1.2		KW2 x 4.6D	5mm	114	Panel - Transparent Base
R508TCWH	24	1.2		KW2 x 4.6D	5mm	114	Panel - White Base
R508TD	24	1		KW2 x 4.6D	5mm	114	Panel - White Base
R508TLED	24	1.2		BX8.5D	5mm	132	LED Panel - Grey Base
R508TMGR	24	1.4		B8.4D	5mm	104	Panel - Light Green Base
R508TMRE	24	1.5		BX8.4D	5mm	104	Panel - Red Base
R508TUWH	24	2.4		B9	5mm	116	Panel - White Base
R508TVWH	24	1.4		B29	5mm	117	Panel - White Base
R508TWBR	24	1.2		B8.7D	5mm	106	Panel - Brown Base
R509T	12	1.2		B8.5D	5mm	105	Panel - Black Base
R509TBBK	12	1.2		B8.3D	5mm	108	Panel - Black Base
R509TBE	12	1.5		B8.5D	5mm	105	Panel - Beige Base
R509TBL	12	1.2		BX8.5D	5mm	105	Panel - L Blue Base
R509TBWH	12	2		B8.3D	5mm	108	Panel - White Base
R509TCGY	12	0.5		KW2 x 4.6D	5mm	114	Panel - Grey Base
R509TCGY/1.8	12	1.8		KW2 x 4.6D	5mm	114	Panel - Grey Base
R509TCTR	12	1.2		KW2 x 4.6D	5mm	114	Panel - Transparent Base
R509TCWH	12	1.2		KW2 x 4.6D	5mm	114	Panel - White Base
R509TDBK	12	1.2		T-1/4NW	5mm	112	Panel - Black Base
R509TEBK	12	1.2		BX2D	5mm	111	Panel - Black Base
R509TFBK/12	12	1.2		F4.8	5mm	107	Panel - Black Base
R509TFBK/14	14	1.4		F4.8	5mm	107	Panel - Black Base
R509TFGY	12	1.8		F4.8	5mm	107	Panel - Grey Base
R509TGR	12	2		B8.5D	5mm	105	Panel - Green Base
R509THGY	14	1.2 (60mA)		T-1.1/2TW	5mm	113	Panel - Grey Base
R509TJBR	14	1.2 (65mA)		T3	3mm	118	Panel - Brown Base
R509TKBK	12	1.2		B8.5 S/40	5mm	119	Panel - Black Base
R509TLBK	12	1.2		BG8.5-5.5D	5mm	120	Panel - Black Base
R509TMBE	12	1.5		BX8.4D	5mm	104	Panel - Beige Base
R509TMBK	12	1.2		BX8.4D	5mm	104	Panel - Black Base
R509TML	12	1.2		B8.4D	5mm	104	Panel - Blue Base
R509TMGR	12	2		BX8.4D	5mm	104	Panel - Green Base
R509TMGY	12	0.5		BX8.4D	5mm	104	Panel - Grey Base
R509TMOR	12	1.12		BX8.4D	5mm	104	Panel - Orange Base
R509TOR	12	1		BX8.5D	5mm	105	Panel - Orange Base
R509TPBK	12	1.2		SG8-5.5D	5mm	121	Panel - Black Base

Vehicle Lighting

PART NO.	VOLTS	WATTS	ECE	CAP	SIZE	DIAGRAM	DESCRIPTION
R509TQWH	14	1.2 (65mA)		T3	3mm	122	Panel - White Base
R509TSBK	14	1CP		B11D	7mm	123	Panel - Black Base
R509TVI	12	0.4		BX8.5D	7mm	105	Panel -Violet Base
R509TWGY	12	1.2		B8.7D	5mm	106	Panel - Grey Base
R509TYBK	14	1.4		T5	5mm	124	Panel - Black Base
R512PCB	12	2CP		P.C.B.	9mm	128	Panel - White Base
R512TR	12	2CP		B12.3D	9mm	129	Panel - White Base
R512WB	12	2		KW 2.1 x 9.5D	10mm	125	Panel - White Base
R513BWH	24	1.5		BA9d	13mm	115	Panel - White Base
R516	12	5	(W5W)	W2.1x9.5d	10mm	90	Miniature Halogen - Blue
R535	24	21	H21W	BAY9s	9mm	91	Miniature Halogen Brake/Indicator/Reverse/Rear Fog
R566	12	21/4	P21/4W	BAZ15d	25mm	60	Fog/Tail
R567	24	21/4	P21/4W	BAZ15d	25mm	60	Fog/Tail
R569	12	5		G4	9mm	94	Miniature Halogen Halogen Accessory Lamp
R570	12	10		G4	9mm	94	Miniature Halogen Halogen Accessory Lamp
R571	24	20		G4	9mm	94	Miniature Halogen Halogen Accessory Lamp
R573	12	20		G4	9mm	94	Miniature Halogen Halogen Accessory Lamp
R574	24	10		G4	9mm	94	Miniature Halogen Halogen Accessory Lamp
R580	12	21/5	W21/5W	W3 x 16q	20.5mm	74	Brake/Tail
R581	12	21	PY21W	BAU15s (OSP)	25mm	54	Indicator - Amber
R581LL	12	21	PY21W	BAU15s (OSP)	25mm	54	Long Life Indicator - Amber
R582	12	21	W21W	W3 x 16d	20.5mm	72	Brake/Indicator/Reverse/Rear Fog
R585	12	21	WY21W	W3 x 16d	20.5mm	73	Indicator - Amber
R586	12	21		BAU15s (OSP)	25mm	54	Brake/Indicator/Reverse/Rear Fog
R588	24	21	PY21W	BAU15s (OSP)	25mm	54	Indicator - Amber
R589	12	10	RY10W	BA15s (SCC)	18mm	62	Indicator - Amber
R606	24	44		P36s	28mm	50	Headlamp
R609	6	15	S3	P26s	25mm	31	Headlamp
R610	12	15	S3	P26s	25mm	31	Headlamp
R613	12	20		P26s	25mm	31	Headlamp
R621	24	36		BA15s SCC	38mm	46	Headlamp
R623	24	48		BA15s SCC	38mm	46	Headlamp
R641	6	3		BA9s MCC	11mm	101	Panel
R64122	12	3		B10D	8.8mm	110	Halogen Panel - Brown Base
R64124	12	5		B10D	8.8mm	110	Halogen Panel - Black Base
R643	12	2.2		BA9s MCC	11mm	101	Panel
R650	24	2.8		E10/13 MES	11mm	97	Panel
R651	24	2.8		BA9s MCC	15mm	99	Panel
R653	24	6		S8.5d	11 x 38mm	84	Festoon
R6929	24	1.2		BAX EBSR	5mm	109	Panel - Light Green Base
R695	24	2.8		E10/13 MES Tub.	9mm	98	Panel
R7027	12	35/35		P15D-3	30mm	33	Motorcycle Headlamp
R7028	12	45/40		P15D-3	30mm	33	Motorcycle Headlamp
R708	12	35	H8	PGJ19-1	11.6mm	11	Halogen Headlamp
R709	12	65	H9	PGJ19-5	11.6mm	13	Halogen Headlamp
R710	12	42	H10	PY20d	16mm	15	Halogen Headlamp
R711	12	55	H11	PGJ19-2	11.6mm	16	Halogen Headlamp
R712	12	53	H12	PZ20d	16mm	17	Halogen Headlamp
R715	12	55/15	H15	PGJ26t-1	22mm	19	Halogen Headlamp
R716	12	19	H16	PGJ19-3	11.6mm	20	Halogen Headlamp
R718	12	55	H18	PY26d	15mm	21	Halogen Headlamp
R740	12	20		BA15s (SCC)	9mm	93	Miniature Halogen Interior
R741	24	20		BA15s (SCC)	9mm	93	Miniature Halogen Interior
R780	12	21/5	PR21/5W	BAW15d	25mm	59	Brake & Tail - Red
R782	12	21	PR21W	BAW15s	25mm	55	Brake - Red
R795	12	50		BA15s (SCC)	9mm	93	Miniature Halogen Interior
R796	12	35		BA15s (SCC)	9mm	93	Miniature Halogen Interior
R801	12	5	W5W	W2.1 x 9.5d	10mm	67	Ring IceBlue Side & Tail/ Interior
R804	12	12		B22d LBC	38mm	133	Bus Interior
R805	12	12		BA15d SBC	38mm	132	Bus Interior
R810	12	24		BA15d SBC	38mm	132	Bus Interior
R816	24	12		B22d LBC	38mm	133	Bus Interior
R817	24	12		BA15d SBC	38mm	132	Bus Interior
R821	24	20		B22d LBC	38mm	133	Bus Interior

PART NO.	VOLTS	WATTS	ECE	CAP	SIZE	DIAGRAM	DESCRIPTION
R822	24	20		BA15d SBC	38mm	132	Bus Interior
R8328	24	1.2		EBSN10	5mm	126	Panel - Beige Base
R833	12	4	T4W	BA9s (MCC)	Tub.9mm	65	Ring IceBlue Side & Tail
R85122	85	35	D2S	P32d-2	9mm	24	Gas Discharge Headlamp
R85402	85	35	D1S	PK32d-2	9mm	23	Gas Discharge Headlamp
R86021001	12	1.2		BAX EBSR	5mm	109	Panel - Green Base
R86021002	12	1.8		BAX EBSR	5mm	109	Panel - Blue Base
R86021003	24	1.2		EBS-N	5mm	126	Panel - Yellow Base
R86024918	24	1.2		BAX10D	5mm	126	Panel - Grey Base
R86028166	24	2.4		BAX10D	5mm	126	Panel - Yellow Base
R862	12	5		E10/13 MES	15mm	96	Panel
R864/14	14	0.5		E5/8 LES	Tub.7mm	98	Panel
R865	24	2.8		BA9s MCC	11mm	101	Panel
R874	28	7		BA15s (SCC)	16mm	61	Side & Tail
R875	28	7		BA15d (SBC)	16mm	63	Side & Tail
R880	12	27	H27W/1	PG13	9mm	35	Halogen Headlamp
R88005996	12.6	1.5		PCB EBS - P/Pm	5mm	127	Panel - White Base
R881	12	27	H27W/2	PGJ13	9mm	36	Halogen Headlamp
R885	12	50		PG13	9mm	37	Halogen Headlamp
R886	12	50		PGJ13	9mm	38	Halogen Headlamp
R887	12	50		PG13	9mm	37	Long Life Halogen Headlamp
R894	12	37.5		PGJ13	9mm	38	Halogen Headlamp
R9003	12	60/55	HB2	P43t	17mm	5	Halogen Headlamp
R9004	12	65/45	(HB1)	P29t	14.7mm	39	Halogen Headlamp
R9005	12	60	HB3	P20d	12mm	6	Halogen Headlamp
R9005XS	12	60	HB3A	P20d	12mm	7	Halogen Headlamp
R9006	12	51	HB4	P22d	12mm	8	Halogen Headlamp
R9006XS	12	51	HB4A	P22d	12mm	9	Halogen Headlamp
R9007	12	65/55	(HB5)	PX29t	33.8mm	39	Halogen Headlamp
R9008	12	60/55	H13	P26.4t	16mm	18	Halogen Headlamp
R9012	12	55	HIR2	PX22d	20mm	22	Halogen Headlamp
R904	12	45/40	R2	P45t	17mm	4	Halogen Headlamp
R905	6	60/55	H4	P43t H4	17mm	5	Halogen Headlamp
R906	12	21		BA15s (SCC)	25mm	93	Miniature Halogen
R908	24	3		S7d	8 x 36mm	86	Festoon
R909	12	21		BA15s (SCC)	16mm	61	Side & Tail
R910	6	35/35	HS1	PX43t	17mm	5	Halogen Headlamp
R911	12	45/40	H4	P43t	17mm	5	Halogen Headlamp
R919	12	65	H9B	PGJY19-5	15mm	14	Halogen Headlamp
R920	12	35	H8B	PGJY19-1	15mm	12	Halogen Headlamp
R921	12	21CP		W2.1 x 9.5d	16mm	70	Brake (High Level Brake Light)
R921A	12	21CP		W2.1 x 9.5d	16mm	71	Indicator - Amber
R922	12	10		W2.1 x 9.5d	14mm	69	Inspection Lamp Bulb
R923	24	10		W2.1 x 9.5d	14mm	69	Side & Tail/Panel/Interior
R925	12	16	PC16WY	PU20d-2	20mm	78	Hipervision Indicator - Amber
R926	12	6	HY6W	BAZ9s	9mm	89	Miniature Halogen - Amber
R927	12	21	HY21W	BAW9s	9mm	92	Miniature Halogen - Amber
R928	12	24	P24W	PU20-3	18mm	82	HiPervision Brake/Indicator/Reverse/Rear Fog
R929	12	35/30	HS5	P23t	25mm	30	Motorcycle Headlamp
R950	6	6		E10/13 MES	15mm	96	Panel
R951	6	5		BA9s (MCC)	15mm	66	Side & Tail
R955	12	16	W16W	W2.1 x 9.5d	16mm	70	Brake/Indicator/Reverse/Rear Fog
R958	12	16	WY16W	W2.1 x 9.5d	16mm	71	Indicator - Amber
R960	12	55(85)	H3C	P22d/5	12mm	43	Halogen Headlamp Import - 556
R961	12	55	H3r	PK22sr	12mm	41	Halogen Headlamp Import - 453
R962	12	55/40		P30t-40	14mm	42	Halogen Headlamp Import - 488
R964	12	45/55		P30/22L	16mm	40	Halogen Headlamp Import - 471
R965	12	65/65		P30/22L	16mm	40	Halogen Headlamp Import - 472
R982	6	1.8		E10/13 MES	11mm	97	Panel
R987	12	2.2		E10/13 MES	11mm	97	Panel
R989	12	5		BA9s (MCC)	15mm	66	Panel/Side & Tail
R990	6	3		E10/13 MES	11mm	97	Panel
R992	12	10		BA9s (MCC)	15mm	66	Side & Tail
R993	24	2.8		E10/13 MES	15mm	96	Panel

Vehicle Lighting

PART NO.	VOLTS	WATTS	ECE	CAP	SIZE	DIAGRAM	DESCRIPTION
RIL200	12/230	11		-	-	138	Compact Fluorescent
RX481	12	100	H1	P14.5S	10mm	1	Ring Rally Sport Halogen Headlamp
RX464	12	100	H7	PX26D	11.6mm	10	Ring Rally Sport Halogen Headlamp
RX484	12	100/80	H4	P43T	17mm	5	Ring Rally Sport Halogen Headlamp
RX664	12	80	H7	PX26D	11.6mm	10	Ring Sportz Blue Halogen Headlamp
RX668	12	80	H1	P14.5S	10mm	1	Ring Sportz Blue Halogen Headlamp
RX684	12	100/80	H4	P43T	17mm	5	Ring Sportz Blue Halogen Headlamp
RX1005	12	60	HB3	P20D	12mm	6	Ring Xenon100 Halogen Headlamp
RX1006	12	51	HB4	P22D	12mm	8	Ring Xenon100 Halogen Headlamp
RX1011	12	55	H11	PGJ19-2	11.6mm	16	Ring Xenon100 Halogen Headlamp
RX1048	12	55	H1	P14.5s	10mm	1	Ring Xenon100 Halogen Headlamp
RX1072	12	60/55	H4	P43T	17mm	5	Ring Xenon100 Halogen Headlamp
RX1077	12	55	H7	PX26D	11.6mm	10	Ring Xenon100 Halogen Headlamp
RX1511	12	55	H11	PGJ19-2	11.6mm	16	Ring Xenon150 Halogen Headlamp
RX1512	12	55	HIR2	PX22D	20mm	22	Ring Xenon150 Halogen Headlamp
RX1548	12	55	H1	P14.5s	10mm	1	Ring Xenon150 Halogen Headlamp
RX1572	12	60/55	H4	P43T	17mm	5	Ring Xenon150 Halogen Headlamp
RX1577	12	55	H7	PX26D	11.6mm	10	Ring Xenon150 Halogen Headlamp
RX2011	12	55	H11	PGJ19-2	11.6mm	16	Ring Xenon200 Halogen Headlamp
RX2072	12	55	H7	PX26d	11.6mm	10	Ring Xenon200 Halogen Headlamp
RX2077	12	60/55	H4	P43t	17mm	5	Ring Xenon200 Halogen Headlamp
RX4048	12	55	H1	P14.5S	10mm	1	Ring Xenon4000 Halogen Headlamp
RX4072	12	60/55	H4	P43T	17mm	5	Ring Xenon4000 Halogen Headlamp
RX4077	12	55	H7	PX26D	11.6mm	10	Ring Xenon4000 Halogen Headlamp
RX5011	12	55	H11	PGJ19-2	11.6mm	16	Ring Xenon5000 Halogen Headlamp
RX5048	12	55	H1	P14.5A	10mm	1	Ring Xenon5000 Halogen Headlamp
RX5072	12	60/55	H4	P43T	17mm	5	Ring Xenon5000 Halogen Headlamp
RX5077	12	55	H7	PX26D	11.6mm	10	Ring Xenon5000 Halogen Headlamp
121030XB	12	10		MR11	34mm	134	Halogen Interior - 30° Angle
61014B		30		T8	3ft	137	3ft White Fluorescent Tube
A1003-R		15		T8	18"	137	18" White Fluorescent Tube
A1021		36		T8	4ft	137	4ft Cool White Deluxe Fluorescent Tube
A1047		15/33		T8	18"	137	18" Cool White Fluorescent Tube
A122030	12	20		MR11	34mm	134	Halogen Interior - 30° Angle
A123530	12	35		MR11	34mm	134	Halogen Interior - 30° Angle
A241012	24	10		MR16/Dichroic	51mm	135	Halogen Interior - 12° Angle
A242038	24	20		MR16/Dichroic	51mm	135	Halogen Interior - 38° Angle
A243538	24	35		MR16/Dichroic	51mm	135	Halogen Interior - 38° Angle
A3003		4		T5	6"	136	6 inch White Fluorescent Tube

Ring	Philips
R465	6258
R455	6336
R319	6402
R317	6498
R384	6499
R383	6503
R423	6620
R392	6718
R244	6814
R205	6821
R206	6822
R282	6829
R253	6844
R990	6875
R641	6910
R293	6929
R393	7008
R9004	9004
R9007	9007
R9008	9008
R9012	9012
R710	9145
R610	12008
R469	12023
R470	12024
R433	12025
R434	12036
R506	12040
R880	12059
R881	12060
R284	12061
R582	12065
R580	12066
R955	12067
R585	12071
R12085	12085
R12086	12086
R782	12088
R237	12144
R927	12146
R005	12221
R002	12222
R504	12256
R12276	12276
R12277	12277
R12278	12278
R479	12311
R453	12336
R435	12356
R708	12360
R709	12361
R716	12366
R240	12401
R335	12442
R385	12445
R012	12475
R904	12475
R780	12495
R581	12496
R380	12499
R381	12503
R286	12516
R715	12580
R566	12594
R509TBBK	12597
R509T	12598
R509TGR	12600
R509TBL	12603
R509TWGR	12604
R64122	12614
R64124	12615

Ring	Philips
R410	12620
R509TMBL	12623
R509TMOR	12624
R509TMBK	12625
R509TMGR	12626
R509TMBE	12627
R459	12636
R509TBE	12637
R509TVI	12640
R394	12718
R395	12728
R396	12748
R273	12803
R270	12807
R245	12814
R209	12822
R281	12829
R256	12843
R239	12844
R268	12848
R267	12850
R272	12854
R269	12860
R258	12864
R264	12866
R987	12875
R643	12910
R288	12913
R280	12926
R233	12929
R297	12960
R501	12961
R501HD	12961
R623	13241
R505	13256
R466	13258
R331	13293
R482	13311
R460	13336
R475	13342
R243	13401
R588	13496
R241	13498
R294	13499
R508	13516
R508TBGY	13597
R508T	13598
R429	13620
R276	13807
R246	13814
R271	13818
R149	13821
R150	13822
R283	13829
R242	13844
R653	13844
R260	13864
R274	13866
R650	13875
R993	13875
R865	13910
R289	13913
R249	13929
R298	13960
R507	13961
R474	13972
R346	24004
R1791	24029
R508TBR	24032
R535	24356
R1471	24506

Ring	Philips
R86021003	24606
R589	12093NA
R12182	12182HTR
R12188	12188NA
R12190	12190NA
R1401	12256BV
R448LL	12258LL/ 12258LLECO
R448	12258PR
R448EQ	12258PR
R4048	12258WHV
R12274	12274SV+
R12275	12275NA
R453LL	12336LL / 12336LLECO
R472HD	12342HD
R472LL	12342LL/ 12342LLECO
R472	12342PR
R472EQ	12342PR
R711	12362PR
R501A	12396NA
R481	12454RA
R581LL	12496LL
R3581	12496SV
R382LL	12498LL/ 12498LLECO
R380LL	12499LL/ 12499LLECO
R245LL	12814LLECO
R207LL	12821LL/ 12821LLECO
R233LL	12929LL
R501LL	12961LL/ 12961LLECO
R477LL	12972LL/ 12972LLECO
R477	12972PR
R477EL	12972PR
R477EQ	12972PR
R460HD	13336MD
R475HD	13342MD
R290	13498MD
R495	13628RA
R295	13814MD
R248	13821MD
R296	13929MD
R474HD	13972MD
R458HD	24362MD
R458	24362MD
R496	24569RA
R42306	42306VI
R42402	42402VI
R42302	42403VI
R42406	42406VI
R85122	85122VI
R85402	85415VI
R9005	9005PR
R9006	9006PR

Ring	Philips
------	---------

Vehicle Lighting

Ring	Osram
R880	880
R881	881
R955	921
R32/3	1157
R12276	2504
R263	2628
R286	2721
R284	2723
R508	2741
R297	2820
R504	2821
R501	2825
R501A	2827
R298	2840
R505	2841
R507	2845
R182	3156
R180	3157
R987	3766
R288	3796
R289	3797
R282	3798
R989	3860
R293	3892
R233	3893
R643	3894
R287	3895
R281	3898
R283	3899
R249	3930
R990	3965
R650	3967
R244	5001
R205	5006
R245	5008
R589	5009
R12085	5201
R12086	5202
R206	5406
R209	5407
R150	5626
R149	5627
R246	5637
R295	5637
R865	6251
R319	6402
R264	6411
R258	6413
R253	6416
R239	6418
R908	6421
R242	6423
R260	6424
R268	6428
R274	6429
R271	6430
R269	6438
R272	6461
R270	6475
R273	6476
R267	6541
R312	6721
R641	6910
R393	7130
R566	7225
R381	7240
R392	7323
R395	7327
R396	7351
R185	7447
R005	7468
R317	7501
R585	7504
R582	7505
R581	7507
R588	7510
R241	7511
R580	7515
R384	7517
R380	7528
R243	7529
R294	7537
R383	7540
R623	7668
R423	7950
R429	7952
R276	8480
R9004	9004
R9005	9005

Ring	Osram
R9006	9006
R9007	9007
R9008	9008
R9012	9012
R710	9145
R290	9511
R496	62248
R498	62249
R469	64111
R470	64113
R433	64115
R434	64132
R435	64136
R535	64138
R455	64147
R448	64150
R453	64151
R466	64155
R460	64156
R465	64168
R479	64173
R482	64175
R715	64176
R410	64183
R459	64185
R472	64193
R475	64196
R024	64199
R477	64210
R477EL	64210
R711	64211
R708	64212
R709	64213
R474	64215
R920	64242
R919	64243
R394	64326
R417	64327
R85402	66140
R85122	66240
R42302	66340
R42306	66350
R42402	66440
R42406	66450
R66548	66548
R472EQ	94193
R509TOR	2321MFX
R509TVI	2322MFX
R509TML	2351MFX6
R509TMBK	2351MFX6
R509TMGR	2352MFX6
R509TMBE	2452MFX6
R509TMOR	2473MFX6
R509T	2721MF
R509TBBK	2721MF8
R509TWGR	2721MF8W
R509TBL	2721MFX
R509TGR	2722MF
R509TFBK/14	2722MF
R509TBWH	2722MF8
R509TWGY	2722MF8W
R508T	2741MF
R508TBGY	2741MF8
R508TBR	2741MFX
R509TBE	2752MF
R801	2825CBI
R1401	2825HCBI
R516	2825HCBI
R501LL	2825ULT
R506	2886X
R183	3757AK
R833	3893CB
R207LL	5007ULT
R245LL	5008ULT
R481	62200SBP
R64122	64122MF
R64124	64124MF
R927	64137ULT
R4048	64150CBI
R448EQ	64150S
R448LL	64150ULT
R460HD	64156TSP
R718	64180L
R239LL	6418ULT
R472LL	64193ULT
R475HD	64196TSP
R012	64198SB
R477LL	64210ULT
R474HD	64215TSP

Ring	Osram
R458HD	64216TSP
R716	64219L
R254	6486X
R382LL	7506ULT
R3581	7507LDA
R581LL	7507ULT
R782	7508LDR
R380LL	7528ULT
R780	7538LDR
R3782	7538LDR
R3780	7538LDR
R9003	9003L
R9005XS	9005XS
R9006XS	9006XS
R958	921NA

Ring	GE
R501	501
R504	504
R317	1053
R581	1056
R335	1058
R385	1059
R241	1060
R346	1061
R588	1073
R384	1076
R380	1077
R294	1078
R381	1098
R243	1115
R566	1122
R240	1143
R423	1926
R410	1931
R429	1937
R206	2614
R205	2615
R209	2618
R150	2626
R149	2627
R244	2639
R210	2640
R246	2643
R293	2659
R288	2660
R249	2661
R233	2662
R289	2663
R987	2683
R862	2683
R283	2692
R281	2696
R282	2960
R286	5301
R505	5305
R297	5313
R582	7440
R580	7443
R253	7544
R239	7546
R242	7552
R258	7575
R264	7576
R260	7579
R274	7580
R269	7585
R267	7592
R270	7593
R276	7595
R9004	9004
R498	52660
R904	52950
R85122	53500
R85402	53620
R435	53990
R535	54400
R433	56110
R469	58540
R470	58560
R467	58570
R468	58580
R392	91210
R393	91220
R395	91221
R396	91231
R398	91232
R508	91602
R284	91605
R507	91622
R1791	91693
R1471	91693
R263	91701
R271	91702

Ring	GE
R272	91715
R273	91761
R581LL	1056LFD
R343	1057L
R382LL	1057LFD
R290	1060HD
R291	1061HD
R380LL	1077LFD
R207LL	2619LFD
R247	2626HD
R248	2627HD
R245	2641/2641T
R245LL	2641LFD
R295	2643HD
R296	2661HD
R233LL	2662LFD
R501A	501A
R448	50310/1U
R448LL	50310DPU
R4048	50310SBU
R466	50320/1U
R453LL	50340DPU
R453	50340U
R460	50350U
R460HD	50350U_HDL
R495	50400U
R479	50410U
R482	50420U
R472LL	50440DPU
R472	50440HU
R475	50450U
R459	50470U
R012	52070U
R024	52080U
R481	52140U
R496	52710U
R497	52730U
R434	52830U
R509T	5301PS
R508T	5302PS
R509TGR	5303PS
R9005	53060U
R9006	53070U
R710	53080U
R708	53090HU
R709	53100U
R42302	53660U
R42402	53670U
R9012	54430U
R880	54480U
R881	54490U
R477LL	58520DPU
R477	58520U
R477EL	58520U
R477EQ	58520U
R474HD	58521HDLU
R458HD	58521HDLU
R474	58521U
R585	7440NA
R239LL	7546LFD
R509TCGY	91609PS
R509TCGYFR	91609PS/91608PS
R801	91625 BLUE
R509TMBK	91641PS
R509TMGR	91645PS
R509TMBE	91646PS
R509TWBR	91651PS
R509TBWH	91665PS
R509TBBK	91671PS
R509TFBK/14	91695PS14V
R86021002	91696PS
R501LL	930LFD
R955	W16W
R958	WY16WNAL

Ring	GE
------	----

Vehicle Lighting

Ring	Lucas
R002	LLB002
R005	LLB005
R012	LLB012
R024	LLB024
R447	LLB0452
R961	LLB0453
R446	LLB0456
R462	LLB0457
R964	LLB0471
R965	LLB0472
R962	LLB0488
R3603	LLB1006
R3625	LLB1010
R7027	LLB1011
R7028	LLB1012
R862	LLB1024
R417	LLB1052
R266	LLB1060
R418	LLB1064
R384	LLB1074
R149	LLB149
R150	LLB150
R509TFBK/14	LLB1587
R180	LLB180
R183	LLB180A
R182	LLB182
R184	LLB182A
R925	LLB183a
R12277	LLB184
R185	LLB185
R12190	LLB186A
R12188	LLB187A
R12085	LLB188
R12276	LLB189
R9012	LLB190
R12275	LLB192
R205	LLB205
R206	LLB206
R209	LLB209
R210	LLB210
R240	LLB211
R243	LLB212
R385	LLB213
R921A	LLB221A
R227	LLB227
R233	LLB233
R233LL	LLB233LL
R239	LLB239
R239LL	LLB239LL
R241	LLB241
R347	LLB241AMBER
R242	LLB242
R242G	LLB243GT
R244	LLB244
R589	LLB245A
R245LL	LLB245LL
R245	LLB245S
R246	LLB246
R248	LLB248
R249	LLB249
R253	LLB253
R254	LLB254
R256	LLB256
R271	LLB257
R258	LLB258
R260	LLB260
R261	LLB261
R263	LLB263
R264	LLB264
R265	LLB265
R267	LLB267
R268	LLB268
R269	LLB269
R270	LLB270
R272	LLB272
R273	LLB273
R274	LLB274
R275	LLB275
R276	LLB275A/LLB276
R280	LLB280
R281	LLB281
R282	LLB282
R283	LLB283
R284	LLB284
R286	LLB286
R286A	LLB286A

Ring	Lucas
R286B	LLB286B
R286G	LLB286G
R509TPBK	LLB286MFHZ
R509TKBK	LLB286MFSL
R509TMGY	LLB286PA
R509TCGY/1.8	LLB286PA
R509TCWH	LLB286PA
R509TCGYFR	LLB286PB
R286R	LLB286R
R509T	LLB286TAC
R509TEBK	LLB286TB1
R86021002	LLB286TBL
R509TFBK/12	LLB286TFB
R509TDBK	LLB286TFB1
R509TFGY	LLB286TFG
R509TWGY	LLB286TG
R509TMLB	LLB286THB
R509TMBE	LLB286THB
R509TMBK	LLB286THBL
R509TMGR	LLB286THLG
R509TMOR	LLB286THO
R509TGR	LLB286TLG
R509TOR	LLB286TO
R509TWGR	LLB286TV
R509TBBK	LLB286TVW
R509TBWH	LLB286TW
R287	LLB287
R288	LLB288
R289	LLB289
R290	LLB290
R291	LLB291
R293	LLB293
R294	LLB294
R609	LLB295
R295	LLB295
R297	LLB297
R610	LLB298
R317	LLB317
R319	LLB319
R330	LLB330
R331	LLB331
R333	LLB333
R334	LLB334
R335	LLB335
R339	LLB339
R343	LLB343
R344	LLB344
R345	LLB345
R346	LLB346
R436	LLB348
R380	LLB380
R32/3	LLB380D
R380LL	LLB380LL
R381	LLB381
R382LL	LLB382LL
R383	LLB383
R780	LLB383
R782	LLB385
R392	LLB392
R393	LLB393
R394	LLB394
R395	LLB395
R396	LLB396
R398	LLB398
R410	LLB410
R416	LLB416
R4187	LLB4187
R4192	LLB4192
R423	LLB423
R429	LLB429
R433	LLB433
R470	LLB433A
R569	LLB433B
R434	LLB434
R535	LLB435
R435	LLB436
R442	LLB442
R444	LLB444
R448	LLB448
R448LL	LLB448LLP
R448EQ	LLB448P
R449	LLB449
R453	LLB453
R455	LLB455
R456	LLB456
R457	LLB457

Ring	Lucas
R4598	LLB4598
R460	LLB460
R460HD	LLB460HD
R465	LLB465
R466	LLB466
R467	LLB467
R468	LLB468
R741	LLB469
R740	LLB470
R472	LLB472
R459	LLB472A
R472HD	LLB472HD
R472LL	LLB472LLP
R474	LLB475
R496	LLB475R
R498	LLB475R
R477	LLB477
R477EL	LLB477
R477LL	LLB477LLP
R479	LLB479
R482	LLB480
R481	LLB481
R4896	LLB4896
R493	LLB491
R494	LLB492
R495	LLB495
R497	LLB497
R501	LLB501
R501A	LLB501A
R501LL	LLB501LL
R504	LLB504
R505	LLB505
R507	LLB507
R508	LLB508
R508A	LLB508A
R508B	LLB508B
R508TUWH	LLB508B9
R86021003	LLB508EBSN1
R8328	LLB508EBSN10
R508G	LLB508G
R508TCWH	LLB508P
R508R	LLB508R
R508T	LLB508TAC
R1471	LLB508TB
R508TWBR	LLB508TBN
R508TBR	LLB508TBR
R508TMGR	LLB508TGN
R508TBY	LLB508TGY
R1791	LLB508TY
R512PCB	LLB512
R512TR	LLB512TF10
R512WB	LLB512WP
R588	LLB558
R566	LLB566
R567	LLB567
R580	LLB580
R581	LLB581
R581LL	LLB581LLPX2
R582	LLB582
R585	LLB582A
R586	LLB583
R621	LLB621
R641	LLB641
R643	LLB643
R650	LLB650
R651	LLB651
R653	LLB653
R695	LLB695
R64124	LLB700
R64122	LLB700A
R708	LLB708
R709	LLB709
R710	LLB710
R711	LLB711
R712	LLB712
R715	LLB715
R716	LLB716
R475	LLB775
R475HD	LLB775HD
R454	LLB785
R795	LLB795 / LLB1050
R796	LLB796
R804	LLB804
R805	LLB805
R810	LLB810
R816	LLB816

Ring	Lucas
R817	LLB817
R821	LLB821
R822	LLB822
R865	LLB865
R874	LLB874
R875	LLB875
R880	LLB880
R881	LLB881
R886	LLB886
R9004	LLB9004
R9005	LLB9005
R9005XS	LLB9005XS
R9006	LLB9006
R9006XS	LLB9006XS
R9007	LLB9007
R9008	LLB9008
R921	LLB921
R951	LLB951
R955	LLB955
R987	LLB987
R989	LLB989
R990	LLB990 (2w)
R993	LLB993
R85402	LLBD1S
R85122	LLBD2S
R42306	LLBD3R
R42302	LLBD3S
R42406	LLBD4R
R42402	LLBD4S
R801	LLX501BL

Notes

Vehicle Lighting

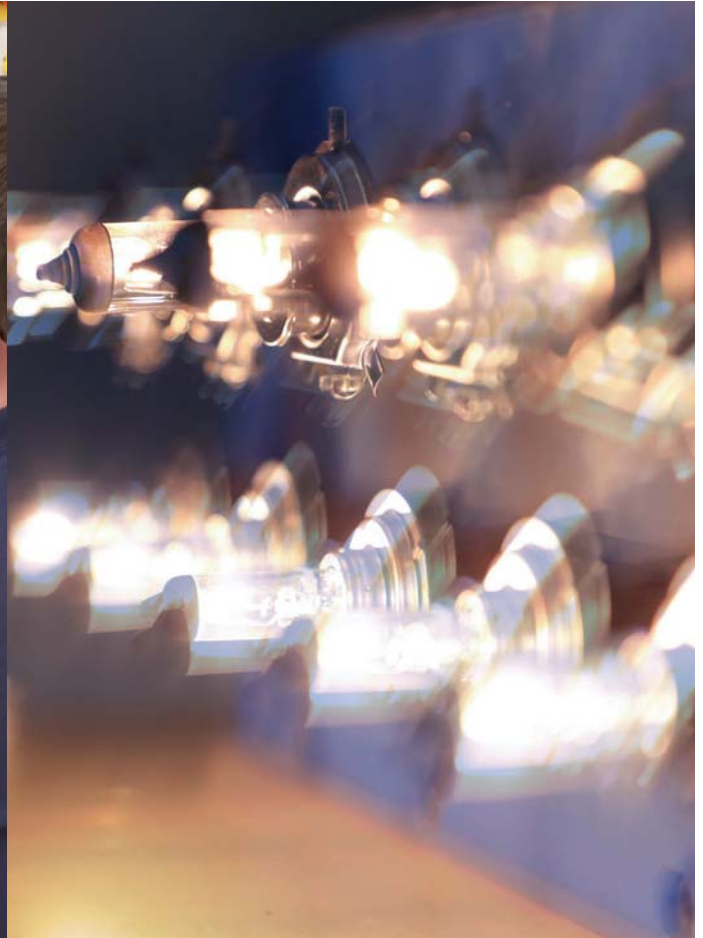

Commitment to Quality

With nearly forty years' experience in the manufacture and distribution of automotive lighting, Ring's commitment to quality is second to none.

Through major investments in test equipment and fully qualified staff, Ring has created a Quality Assurance Department that is at the forefront of Automotive Lighting. Ring recognises quality is of the utmost importance in helping to ensure customer satisfaction and with this in mind Ring's Quality Assurance Department carries out stringent quality control procedures on a continuous basis.

It has achieved the highest standards in Quality Assurance and has been independently assessed by BSI. The department has been awarded ISO:9001 for the manufacture and assembly of automotive lighting. This is regularly and independently verified by BSI and the standard has now been achieved over a period of many years. This independent Quality Assessment is vital when it comes to Ring's original equipment programme where the best in the world OEM's continue to place business with Ring Automotive. The Quality Assurance Department monitors and assesses all the bulbs in the Ring Auto Bulb range. Using the sampling techniques laid down by BS6001 bulbs are checked to the relevant ECE and BS standards.

The Quality Assurance Department carries out a much bigger role than simply testing our existing products.

The department's extensive facilities are used in the continuous process of product development, comparing the performance of existing products to those utilising the very latest technologies. It works closely with our manufacturing partners in developing those new technologies.

It is also able to monitor and assess the general quality of the market place issuing regular updates on other bulbs available. Working in close cooperation with our customers it can issue technical reports on request.



BS EN ISO 9001:2015
FM 504682





Light Tunnel Laboratory

Designed and developed by Ring, the lighting laboratory is a unique installation that allows product testing and performance verification beyond that laid down by international standards.

The state-of-the-art laboratory is equipped with the latest ProMetric CCD light imaging photometer. Where a traditional goniophotometer can only measure the light intensity and colour from the lamp at one point at a time, the new ProMetric photometer can measure 8 million points simultaneously. Localised light and colour difference can easily be detected by looking at the individual measurements taken from any point. These measurements can then be displayed as a conventional image or via a colour isolux image.

These images clearly illustrate the performance of both the light unit and the light source and can be used to access the relative

performance of products. Our extensive database now contains many thousands of results which can be used to improve both our understanding of our products performance but also other products sold in the market.

The data is used to further enhance and improve our products. The specially designed software allows data to be shown as overhead images to produce a bird's eye view of the product's enhanced performance on the road ahead. The performance of products can be checked against the international standards using the reference data points from European headlamp standards.

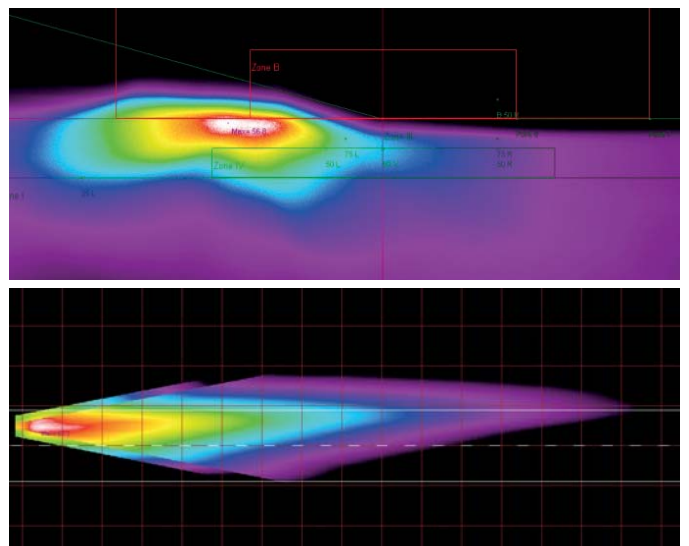

Vehicle Lighting

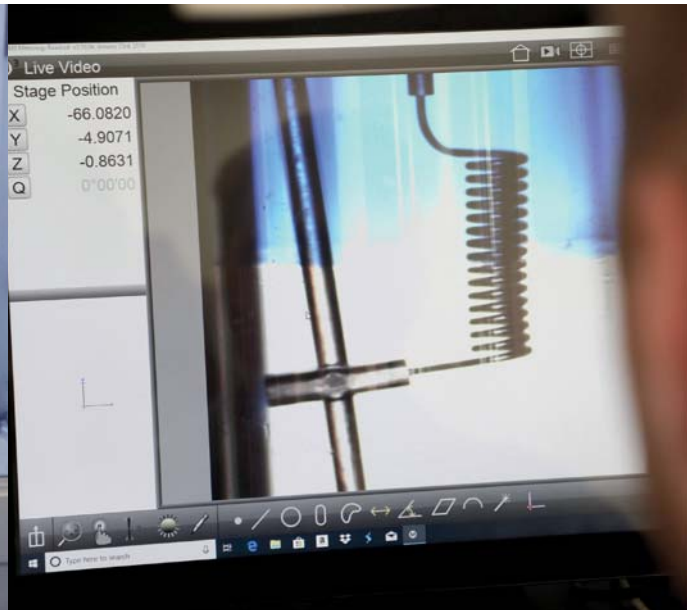

Quality Control

Luminosity and Colour

Using an Integrated Photometer, luminosity or the light output, is measured. This calibrated sphere compares, the light output of the sample against a calibrated bulb from the National Physics laboratory. The light output is then checked and verified against the relevant standard. Bulbs are checked for colour compliance by comparing the output to chromaticity values defined in the standards.

Life Testing

Bulbs are tested for their static life using a computer controlled life test rack.

This accelerates the life of a bulb using increased voltage between 110.0-116.6% as specified by BSI or I.E.C standards.

This life test is not a continuous test, but a cycle test that switches the bulbs off and on, to put the maximum load on the bulbs. In the case of twin filament headlamp bulbs the test alternates between the main and dipped beam filaments.

Lamp Dimensions and Filament Positions

Lamp dimensions and filament positions are verified on a shadowgraph magnification projector.

With the increasing use of complex surface reflectors on both front and rear lighting it is becoming more important that the filament is located at the correct position. Failure to do this will result in a very poor beam pattern as the source of light is not at the focal point of the lamp.

Vibration Testing

Whilst there is no international requirement for vibration testing within ECE specifications, Ring carries out vibration testing in its laboratories.

The amplitude and the frequency of the vibration can be adjusted to create a variety of adverse conditions. This test is the nearest we can get to simulating what happens on the road and is particularly relevant to the arduous conditions found in the commercial vehicle market. Ring is able to benchmark its products and those available in the market place.

Other procedures carried out:

- Envelope to lamp holder test – the bulb is torque tested against calibrated weights to ensure the cap is secure.
- Cap dimensional test – the bulb cap is checked against calibrated gauges to ensure the correct fit to a lamp holder.
- Envelope test – the glass envelope is checked against calibrated gauges to ensure the correct size.



Product Development and Testing

Ring's Quality Assurance Department carries out a much bigger role than simply testing automotive bulbs.

The department's extensive facilities are used in the continuous process of product development, comparing the performance of existing products to those utilising the very latest technologies. It works closely with our engineers in developing those new technologies.

The facilities to capture data and log actual performance together with extensive test equipment provides valuable

assistance in creating new products in the auto electrical and power management product categories.

As new vehicles embrace new technologies such as 'Stop/Start' battery systems Ring already has in place a range of battery chargers to meet the market demand.



Vehicle Lighting

Notes



Brighter Roads Ahead



- **Up to 200% more light*** on the road ahead allowing drivers to see more
- See and be seen with a **longer beam pattern**
- **Better visibility** of road markings and signs
- **Up to 3700K** colour temperature meaning a whiter look in the headlamp compared to a standard bulb
- **No changes** to vehicle wiring required
- Available ECE types: **H4 / H7 / H11**

**compared to standard halogen bulb*



Xenon200

A new dawn for brighter headlight bulbs



Ring Automotive Limited . Gelderd Road, Leeds, LS12 6NA United Kingdom
Telephone +44 (0)113 213 2000 . Fax +44 (0)113 231 0266

Email autosales@ringautomotive.com . www.ringautomotive.com

 /ringautomotive

In line with our policy of continuous product development, Ring Automotive Limited reserve the right to alter specification without notice. Whilst every care has been taken in compiling the information in this catalogue, Ring Automotive Limited cannot accept legal liability for any errors or omissions. Manufacturers' names and part numbers are for reference only. Illustrations are intended only to be representative of the parts offered, sizes quoted are nominal. © Copyright 2019 Ring Automotive Limited.

CAT1688



BS EN ISO 9001:2015
FM 504682

